



DESIGN QUAR- TERLY

ISSUE 18



THE FUTURE OF DESIGN

An integrated approach to making life better

DESIGN QUAR- TERLY

ISSUE 18

**THOUGHTS, TRENDS AND INNOVATION
FROM THE STANTEC BUILDINGS GROUP.**

The Stantec Design Quarterly tells stories that showcase thoughtful, forward-looking approaches to design that build community.

IN THIS ISSUE: THE FUTURE OF DESIGN



When we talk about the future of design the conversation jumps to technology. While tech gets the headlines, the future of design may be about a mindset that isn't new at all.

In this issue, we explore the need to take on more responsibility and design holistically to deal with today's immense challenges and solve some lingering questions like:

How do we harness new technology and automation to engineer and create better design solutions? What problems need to be solved to allow the emerging vertical farming industry to flourish? Can robots help us work safer, smarter, and with less space? Will emerging delivery models deliver on the promise of value for money while protecting design? What do mega factories need to ramp up production in North America?

Change for change's sake may sell gadgets, but progress is built on small innovations that make life better.

01

Making the must-haves for a sustainable future

Ramping up advanced manufacturing in the U.S. requires an integrated approach.

BY GREG HALL

18

Cutting down on cut and paste

Our new engineering system solver GeneSys automates the repetition out of conceptual design.

BY OLIVER VILÉ

07

Space explorer

We built an Indoor Air Quality Robot to scan the workplace.

BY RICK HUIJBREGTS

23

Protecting design intent

Can emerging delivery processes result in better hospitals?

BY SUZANNE CRYSDALE

12

Ripe for innovation

Scaling up vertical farming is a tricky business

BY BRIAN MCCLELLAND

31

The future of design: a conversation

Will technology change the architect's role?

BY MICHAEL BANMAN AND DAVID MARTIN

MAKING THE MUST-HAVES FOR A

SUSTAINABLE FUTURE

Ramping up advanced manufacturing in the U.S. requires an integrated approach.

BY GREG HALL

Diversifying energy production is one of the most important global challenges we need to solve this decade to secure a sustainable future for our planet. Currently, from a United States perspective, this future depends on advanced technology built on the other side of the world. With the resiliency and reliability of the global supply chain in question, there's a push to bring the technology closer to the end user, while diversifying our energy supply in the process. If the technology we use to achieve the transition to renewable energy is closer to home, we stand a better chance of keeping up with demand while strengthening our economic security against foreign energy sources. ☺

WHAT IS ADVANCED MANUFACTURING?

When we're talking about advanced manufacturing, we're talking about facilities that make three kinds of products: semiconductors, solar panels, and batteries for electric vehicles. These three industrial categories are related because they use sophisticated robotic automation, contain hazardous material, and require wastewater mitigation and various levels of clean room space at a large scale. In the case of semiconductors and solar panels, they use similar raw materials: primarily sand transformed into polysilicon.

Investment in a domestic market for advanced manufacturing in North America is ramping up. There are several trends driving this.

1 RESHORING

Disruptions in the global economy in recent years have shown a lengthy supply chain is not always resilient or economically beneficial. Offshoring looks less enticing than ever for many manufacturers. As a result, there's a trend toward reshoring manufacturing underway; bringing factories to North America, closer to the places

where consumers live. So instead of shipping products across the planet to get to one of the largest consumer markets, the United States, manufacturers are looking for opportunities to make things here.

2 AUTOMATION

Rapid advances in automation are changing the nature of manufacturing. Robotics and automated systems are driving a boom in North American manufacturing by increasing productivity and reducing reliance on some kinds of labor. Generally speaking, high tech manufacturing requires fewer, but more highly skilled workers, but also demands a hearty capital investment to get off the ground.

3 INCENTIVES

Previously, regulations and high costs discouraged new large-scale investment in manufacturing, but recent legislation has changed the equation with new tax incentives and tax deferrals to bring manufacturing and the job opportunities that come with it back to the United States. The Creating Helpful Incentives to Produce Semiconductors for America (CHIPS) Act authorized 24 billion dollars in investment tax credits

for semiconductor chip manufacturers, while the Inflation Reduction Act offered tax credits to solar panel component manufacturers. The result is that companies that considering reshoring or building up manufacturing capacity domestically are swinging into action, and in some cases, enlarging the scale of their plans.

4 DEMAND

The United States is playing catch-up to Europe in adopting electric vehicles, diversifying energy sources away from fossil fuels, and implementing solar power and electrification. Manufacturers see the U.S. as a ready market for advanced manufacturing products to enable its energy transition away from fossil fuels to renewables.

5 RESOURCES

Manufacturers know they can make these products in the U.S. because every single resource they need—the water, the energy, the land, the technical know-how—is readily available. The U.S., for example, has a robust supply of high-purity quartz sand which is essential to solar panel production. ☺

VERTICALLY INTEGRATED SOLAR CELL MANUFACTURE

Qcells' new, state-of-the-art facility will manufacture 3.3 gigawatts of solar ingots, wafers, cells, and finished panels annually.

Qcells is a subsidiary of Hanwha Solutions, one of the world's largest manufacturers of photovoltaics (PV). Qcells is planning to boost its solar module production capacity in the United States from 1.7 gigawatts in 2022 to 8.4 gigawatts by 2024. The company is investing \$2.5 billion, the largest solar investment in U.S. history, to build a new solar power manufacturing facility in Georgia near its existing 300,000 SF solar panel factory. With 3.3 gigawatts annual manufacturing capacity per value chain, the new facility will be the largest fully integrated solar manufacturing site in the nation, employing an additional 2,500 workers.

Gray Construction, a leading global builder in the manufacturing industry, and Stantec, a global leader in sustainable design, were selected by Hanwha to design and deliver the massive project.

[**LEARN MORE ABOUT THE QCELLS PROJECT**](#)



HOW ARE SOLAR CELLS MADE?

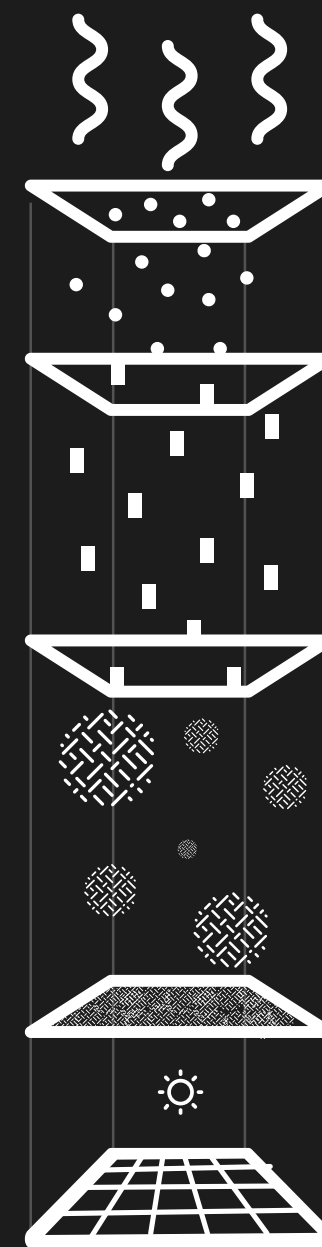

Ingot Production

Manufacturer reduces and purifies silicon dioxide in quartz then casts it into ingots of pure silicon. Sometimes, they “dope” the silicon at this stage to make it electrically conductive.

Wafer Processing

Manufacturer processes silicon ingots into blocks then slices those into hexagonal or rectangular shapes.

Cell Processing

In this multistep process, the manufacturer tests, cleans, adds texture, acid rinses the cells, then adds a dopant to make the cell more conductive. It etches and edges the cell's electrical path, then washes it, adds an anti-reflective coating, prints contacts on the wafer, then dries them in a furnace. Next, they test and sort solar cells by efficiency.

WHAT THEY'RE MAKING

There are numerous similarities between the manufacture of semiconductors and solar panels. In both, manufacturers grow crystals in a high-temperature, controlled environment, sew the silicon into thin wafers, process or coat the wafers into a cell and then laminate/wire/encase them into a final product.

UNDER ONE ROOF

The largest of these projects brings together multiple industrial processes under one roof. Hanwha Qcells' new facility in Georgia combines four processes and will be among the world's largest advanced manufacturing facilities. Its massive assembly lines will transform quartz sand to polysilicon, produce finished solar panels, and ship them out. The new facility will house the entire solar panel manufacturing process, including ingot production, wafer processing, cell processing, and module production.

Advanced manufacturing facilities face their own set of challenges, many of which we believe require an integrated approach. ☺

DAY ONE OPERATION

These sophisticated, complex large-scale buildings for global manufacturers tend to be fast-track delivery projects. Staying on schedule is always a priority, but the scale of investment in advanced manufacturing, and its high operating costs, require precise planning and execution to meet business goals. So, opening on day one is key to the financial success of these projects. Thus, we need to approach design and procurement of materials and equipment as simultaneous undertakings to meet deadlines.

This is where the integrated approach of a firm like Stantec is highly advantageous. On the Hanwha project, Stantec is providing integrated services across disciplines and locations including architecture, MEP (mechanical, electrical, and plumbing) services, structural engineering, fire protection, environmental, civil engineering, and water and wastewater components.



WASTEWATER EQUIPMENT AND RECYCLING

Advanced manufacturing facilities have a high demand for water and electricity. Large, advanced manufacturing facilities need some kind of wastewater treatment. Some will need a facility to pretreat and offload their wastewater to a local wastewater facility and regional authorities.

But another option for these facilities is recycling wastewater and that's where it gets interesting. Wastewater recycling at the industrial scale requires advanced equipment and membranes used in a complex process that can strip out the caustic chemicals and deliver ultra-pure water. The scarcity and long lead



**Tesla Water
Treatment Facility**
Tracey, CA

times for specialized equipment can potentially delay a project.

An integrated wastewater team can provide more than standard services, it can draw on insights and formulate innovative solutions. Our job as an integrated and experienced designer of industrial spaces is to source alternative configurations that will allow procurement and keep the project on track. We can source alternative equipment in place of the hard-to-get pieces to stay on schedule. ☺

Installed solar energy capacity

Cumulative installed solar capacity, measured in gigawatts (GW).

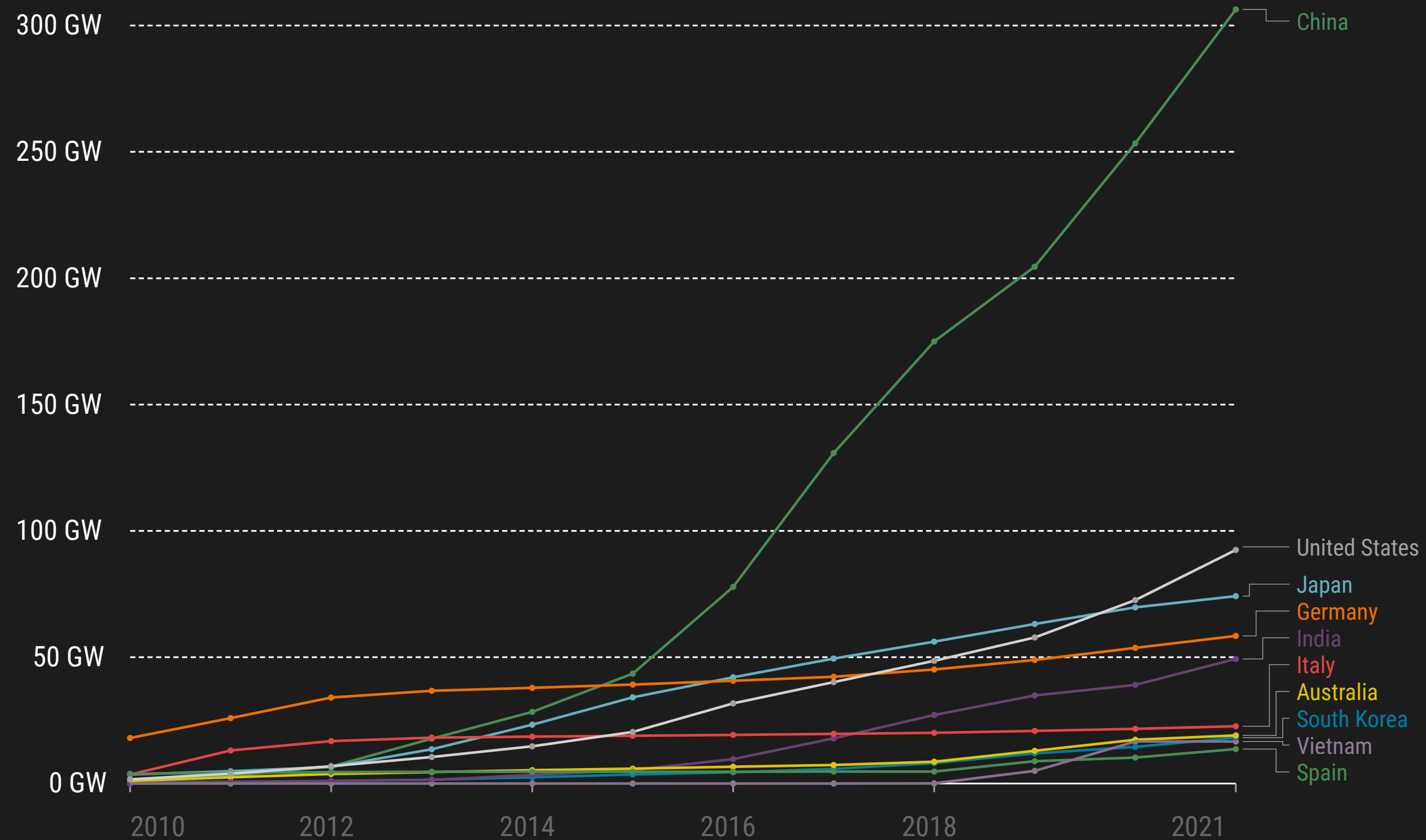

TAKING FULL ADVANTAGE OF AUTOMATION

Korean, Taiwanese, and American manufacturers who want to compete with China in solar panel manufacturing are looking for opportunities to automate some of their manufacturing and finishing processes as they open or increase operations in the U.S. They can benefit from integrated approaches to design and engineering these facilities to make them more efficient, and they need experts who can advise them on everything from systems, processes, power, and water.

CLEANROOMS

Manufacturing and testing semiconductors is a delicate and exacting process that's required to meet high standards. Much of the semiconductor chip fabrication process must take place in a cleanroom to ensure quality and functionality. The smallest speck of dust and dirt can wreak havoc on a microchip. Cleanrooms vary in process type, line width, and wafer size requirements. ☺

Source: Our World in Data based on BP Statistical Review of World Energy

OurWorldInData.org/energy • CC BY

INTEGRATED ADVANTAGE

When it comes to building advanced manufacturing facilities, we believe an integrated approach drawing on internal experts from related markets and industries is powerful. It gives us the ability to tap into specialists who work in the science and tech industry and know how to design systems to handle hazardous material and gases. It means we can utilize our lab planners who design cleanrooms. Stantec brings years of experience in cleanroom design for biotechnology laboratories, research facilities, and high-tech manufacturing to advanced manufacturing projects. We team up with our innovators in wastewater management and power to make these resource hungry facilities as efficient, safe, and resilient as possible. 

✓ [RETURN TO TABLE OF CONTENTS](#)

MORE MANUFACTURING

Based in Pittsburgh, PA, [Greg Hall](#) is a member of the Industrial Buildings leadership. He focuses on projects in the advanced manufacturing and warehouse, distribution, and logistics market sectors.



**Mercedes-Benz
Canada Inc.
Fuel Cell Stack
Manufacturing
Clean Room**
Burnaby, BC

SPACE EXPLORER

Why we built an Indoor Air Quality Robot to scan the workplace.

BY RICK HUIJBREGTS

OUR EXPECTATIONS FOR THE WORKPLACE ARE CHANGING. WITH PANDEMIC ANXIETY AND PROTOCOLS FADING, PEOPLE ARE SPENDING MORE TIME IN THE OFFICE. WITH A HEIGHTENED AWARENESS ABOUT AIR QUALITY AND HEALTH AND SAFETY IN THE WORKPLACE, EMPLOYERS ARE RETHINKING HOW THEY SUPPLY SAFE AND COMFORTABLE SPACES TO SUPPORT A BROADER RETURN TO THE OFFICE.

At the same time, new standards and regulations are emerging around healthy and safe buildings, particularly in North America. Our clients are hungry for knowledge about where they stand in relation to these new regulations. For instance, the new WELL Building Standard (which rates buildings in relation to human health) is taking the real estate industry by storm as more than 40% of property owners and tenants are pursuing WELL to show employees and clients the depth of their commitment to their well-being. Meanwhile the conversation around space utilization has resumed. ☺

Owners, operators, and managers want to know how space is being used relative to productivity, efficiency, and occupancy. They want answers to the questions: how much and what kind of space do we really need?

Many companies do not have much insight into how well their workplace spaces perform. Sure, some buildings are outfitted with intelligent systems, sensors, and certain capabilities that they may make available to tenants, but not many.

Companies invite consultants with clipboards or sensors into the workplace in hopes of gaining that insight. They walk around, they scan the space. There is a lot of human labor involved to create snapshots of the workplace, observing standards and performance in terms of occupancy, air quality, and temperature. One alternative is for building owners to invest heavily in technology to gain

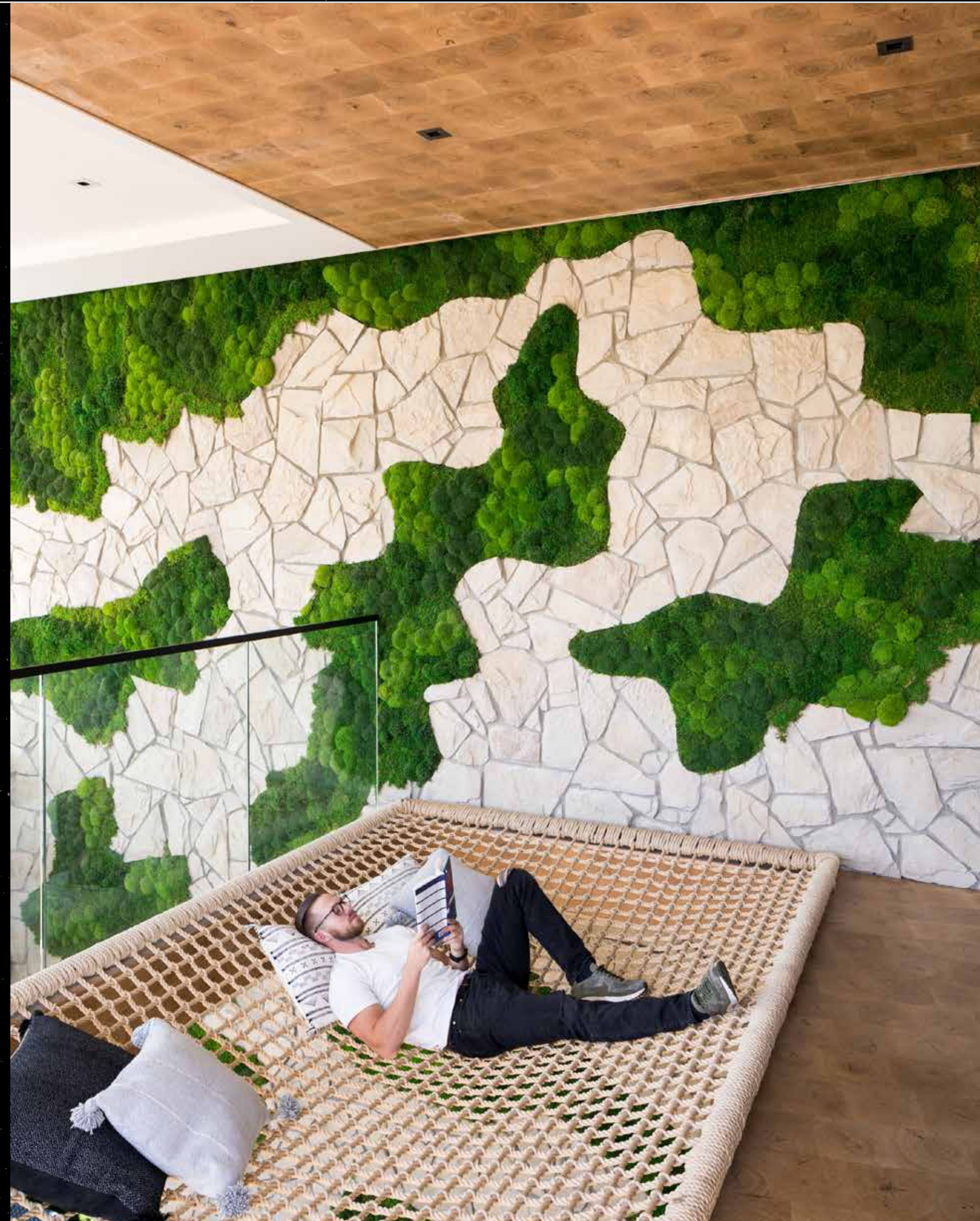

BPX Energy

Denver, CO

Wellness is at the forefront of the new workplace for many employers.

occupancy insights—installing sensors and cameras everywhere to extract information from the built environment. But that solution is expensive.

A NEW IDEA

But what if we could provide data collection and analysis as an automated service? What can we do to quickly assess the built environment and take measurements of the quality of air, the temperature, the noise levels, even occupancy, and light levels? What if employers could get a quick and accurate snapshot of all the essential environmental systems that make employees happier, healthier, more productive? Could we offer that up affordably? Would that help our clients understand their spaces better? ☺

THE IAQ ROBOT "LAYER CAKE"

LAYER FOUR

Integrated specialized expertise and advisory services interpret the data and turn it into insights and recommendations for our clients.

LAYER THREE

The IAQ Robot pushes data to the cloud where our team can monitor it in real time.

LAYER TWO

Our ability to instantaneously collect data through this robotic device.

LAYER ONE

The IAQ Robot makes all this possible and serves as the platform for housing the data.

More than 20 sensors: Indoor air quality, temperature, humidity, pressure, ambient lighting, noise levels, occupancy and more

360°
camera

AI-Enabled

Smart charging
system

Autonomous robot

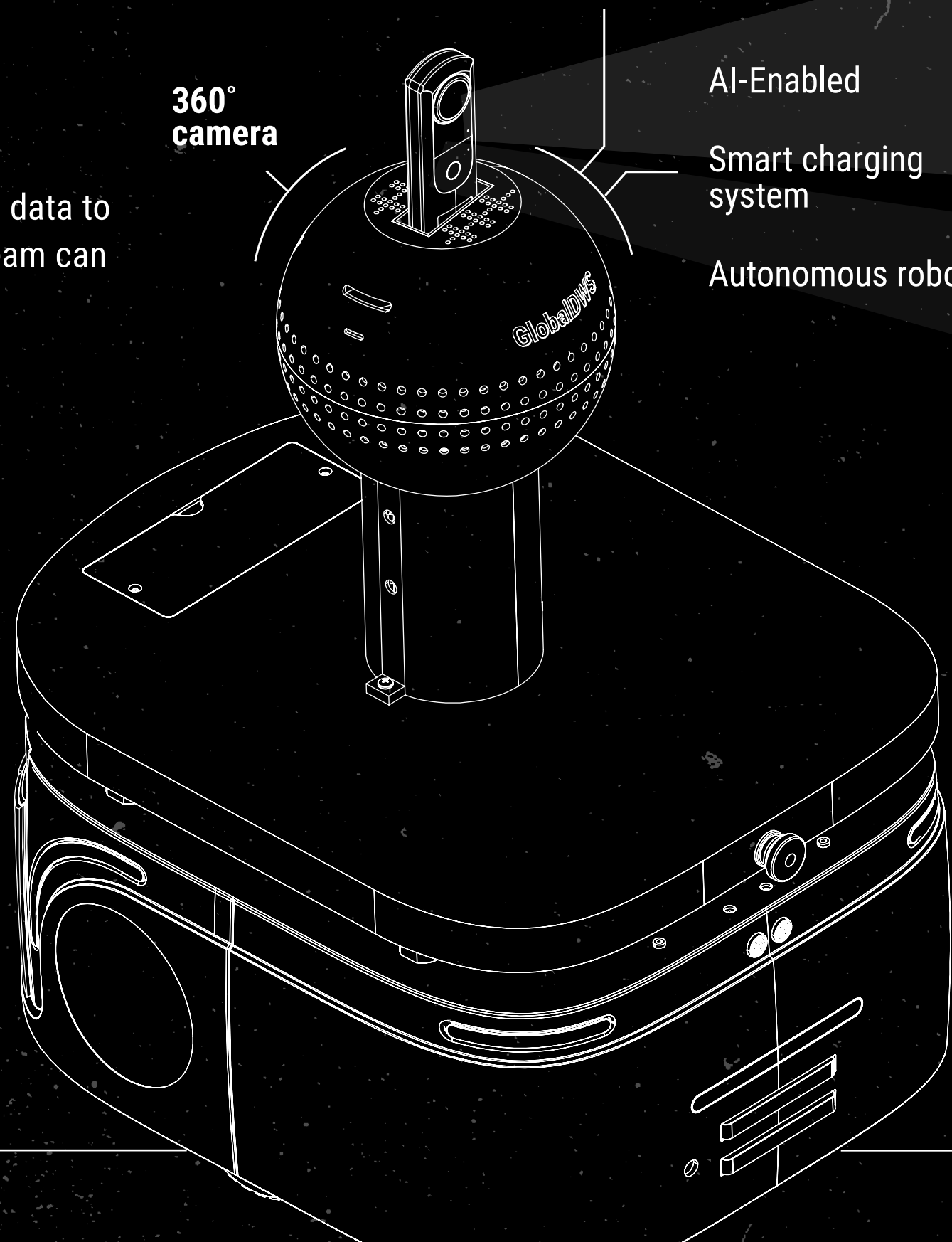

A ROBOT COLLECTS DATA

The answer is yes! With our partner [GlobalDWS](#) we have developed a robotic solution that can safely navigate a client's workspace. Outfitted with a variety of sensors, the IAQ Robot takes readings for indoor air quality, temperature, humidity, pressure, ambient light, noise levels, and more—all relevant data points required for measuring compliance with the WELL rating system. The robot can also count people and monitor their motion to better understand how spaces are being utilized throughout the day. It can also detect health and safety violations such as blocked entryways or obstacles in hallways requiring correction.

HOW IT WORKS

Rather than send in a team to physically observe and record data, we ship the IAQ Robot directly to the site. The robot and its charging station are plug and play. Once charged up and deployed, the robot—in a Roomba-like fashion—follows a preset trajectory to collect data, returning to its charging station as needed, then repeating

the process until it has the data it needs.

We can program the bot to ingest data 24 hours a day or only during working hours. It instantly sends collected data to the cloud, while our team can completely monitor and control the device remotely. After a week or two—the timeline for collecting the data via the bot is determined by the size of the floor and the required accuracy and resolution of data collection—we pick it up.

ROBOT SENSORS/360 FLOORPLAN

In addition to having more than twenty sensors, the robot features a high-definition 3D 360 camera. As the robot maneuvers, it creates a 3D model of the space, a point cloud that can be imported into BIM or a digital twin platform. If a client's floorplan is out of date or non-existent, they will need new images of what's there to verify how things have changed before they make any major decisions. With the IAQ Robot we can provide a high-resolution detailed imagery of the entire space, even multiple floor plates, that we can use to redesign or retrofit the space. ☺

PILOT PROJECT

We recently tested the IAQ Robot in our own Markham, Ontario office.

SITUATION

- ◆ No tenant access to relevant data to make workplace decisions
- ◆ Need for indoor air quality information without property owner involvement
- ◆ Need to generate a 3D as-built model for renovations
- ◆ Don't want sensors or equipment on corporate IT systems

RESULTS

- ◆ Obtained real-time occupancy data
- ◆ Installed temperature alerts near windows to allow temperature adjustment to improve comfort
- ◆ Confirmation that IAQ meets standards—reassuring operators and staff

DEPLOYMENT

- ◆ We deployed **two Stantec IAQ robots** for one week.
- ◆ Scanned workplace for IAQ, light levels, temperature, and occupancy
- ◆ Produced a detailed point-cloud 3D model that can be analyzed and imported into BIM

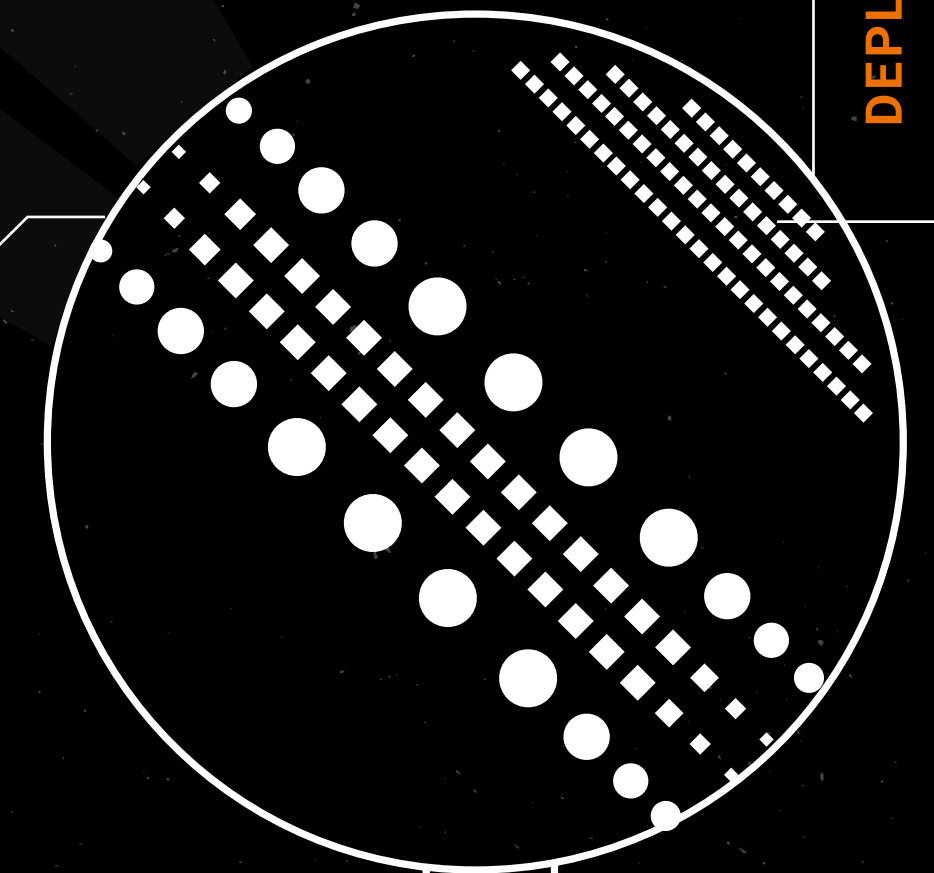

DATA CONTROL

This tool allows us to capture the data in our cloud. Rather than see the data stored with multiple third-party providers, we have 100% control over it. We can manipulate the data, import it, and use it in BIM. So now we have greater ability to look at what solutions or what problems we can solve with our client. We're less restricted in how we use the data, opening new opportunities to explore more holistic solutions, like our digital twin, or other services to support a client's specific needs informed by data.

DATA SECURITY

While scanning, the platform does not capture any personally identifiable data about employees or visitors. It secures the data through encryption and various access control measures. It retains the data only as long as needed for the task to reduce risk. And throughout, we employ data masking so no personally identifiable information is stored.

MAKING THE DATA VISIBLE

The data we collect goes into a dashboard created with our partner [GlobalDWS](#) which allows us and our clients to see the state of their space. Our engineers can extract and analyze this data and give meaningful advice to our clients. "Your space is too hot here." "This corner is rarely used or occupied. It could be better utilized." "We're detecting indoor pollutants in your office."

OFFER ADVICE BACKED BY DATA, STANDARDS

When we make our recommendations, we support them with the client's real-time data. We can point to areas where air quality levels are poor, for example. We can look at how actual conditions match established standards and WELL Building 2.0. We can then advise on actions necessary to address the issues. And as a result, we can make more meaningful and impactful improvements to the quality of space and well-being of people based on a specific set of unique data through targeted design and engineering solutions. ☺

INTEGRATED SERVICES

Together with our client, sharing a clear view of existing conditions on our dashboard, we can assess the next steps. The actions could be anything from a design or engineering systems retrofit to workplace strategy and change management sessions. Our clients benefit from the ability to see a wealth of unique data on their space that will inform important capital decisions like renovation or recommissioning of their systems. If downsizing is required, the data can help them decide how to prioritize space needs.

The difference is that rather than relying only on industry best practices, old benchmarking, and hunches, in using the IAQ Robot we develop a more comprehensive understanding of the client's space utilization, building system health, and occupant comfort. IAQ Robot allows us to tailor a solution to a client's actual conditions and needs

all with the goal of helping them thrive in their workplaces.

CURRENT STATUS

Stantec is rolling out the IAQ Robot with our team, working with clients on a pilot project. Soon the Stantec IAQ Robot will join the full stack end-to-end services we offer. IAQ allows us to bring an integrated approach and the best engineering and design consulting together with the latest in robotics and sensor technology. It's a bold step forward in our quest to design the best workplaces. 

[RETURN TO TABLE OF CONTENTS](#)

MORE SMART BUILDINGS

As Stantec's smart cities global lead, Toronto-based **Rick Huijbregts** applies innovative methodologies that bring together people, processes, places, data, and infrastructure to better understand and transform our urban places and built environment.



HEAR **DR. RICK HUIJBREGTS** ON STANTEC'S DESIGN HIVE PODCAST.



IAQ Robot

Stantec Markham office

We deployed the IAQ Robot on our pilot project at Stantec. Seen here, the robot, in a Roomba-like fashion, follows a preset trajectory in the space, collecting data, returning to its charging station as needed. It goes again and again, repeating the process until it has all the data it needs.





Ripe for innovation

BY BRIAN MCCLELLAND

Scaling up vertical farming
is a tricky business.

Vertical farming is poised to gain momentum in the next ten years, with a nudge from government subsidies, a growing global food demand, climate change concerns, and innovation that makes indoor growing more efficient and profitable. Traditional methods of cultivation are insufficient to meet rising global demand.

There's a place and time for large-scale vertical farming—sometimes referred to as indoor farming or controlled environment agriculture (CEA)—to really take off, but we're not there yet.

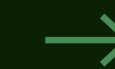

What are food miles anyway?

In much of North America, we've come to expect that we can walk into a supermarket and buy almost any fruit and vegetables we desire, despite the season. This convenience has a cost. In the U.S. and Canada, the food we buy at the grocery store has often traveled thousands of miles before it gets into our shopping cart. Internationally traded food makes up 19% of consumed calories worldwide.

Food miles are the distance our food has traveled from production to consumption. High emissions foods either require more carbon emissions for their cultivation (beef, for example), travel a long way to reach us, or require emission intensive transport methods (think plane). Also, recent studies show that higher

mileage foods can lose their taste and nutritional value on that journey. Seen from a global perspective, food miles are a significant contributor to climate change. Transport accounts for about 19% of total food-system emissions with global food-miles corresponding to 3.0 GtCO₂e (gigatons of carbon dioxide equivalent). 36% of global food miles are from fruit and vegetable transport.

What can we do? The solutions are simple: choose to buy and eat locally or at least opt for more lower mileage foods, waste less food, compost more, even grow your own. On the production side, however, the demand for all-season availability is hard to meet without global transport—which is where vertical farming has an opportunity to enter the market.

Successful pilot projects, small scale

Many of us have seen vertical farming facilities or products in stores, but these are typically pilot projects, either subsidized or not yet profitable. While Europe is racing ahead on controlled environment agriculture, North America has not been able to make CEA work for the long term. Small scale vertical farms, say a shipping container outfitted to grow produce for a village, have been deployed successfully. But scaling up vertical farming is more than a matter of building 200 container farms.

We've yet to see a groundswell in demand for vertical farming. The idea that we can grow plants better than traditional farming methods doesn't get a lot of attention—perhaps because it requires us to upend our vision of the bountiful farm and its expansive fields.

While we're not there yet, there will be a time when more grow-and-buy-local is necessary for supply chain resiliency and efficient resource use. Inevitably, if weather patterns keep changing and if the world's urban population keeps growing, we will need to expand vertical farming and make it work. At some point this century, vertical farming will comprise a significant portion of global food production.

What are the potential advantages of vertical farming?

In the U.S., we get some of our produce, our lettuce or avocados for example, from Mexico or Argentina, places where the climate is favorable year-round. Changing weather patterns, such as extreme drought in California, can affect our food sourcing and supply chain. Although plants can be hearty, we're still at the mercy of weather patterns when it comes to supply.

Through the pandemic we've become aware of our dependency on the global supply chain. Building food supply resiliency means growing more food closer to home. In theory, reducing food miles reduces our energy consumption and emissions related to climate change.

Lighting and irrigation control

The sun is a free resource, but sun exposure to plants varies seasonally. With vertical farming, we replace the sun with lights and tune them to optimize plant growth at each phase. For example, seedlings and sprouts receive less hours of light to mimic springtime's shorter days. ☺

Likewise with irrigation. We can ensure the produce we're growing gets the right amount of light, water, and nutrients (from soil or hydroponics) when required.

When we grow indoors, we remove some of nature's unpredictable variables and add the reliability of traditional food manufacturing. In the end the vertical farms that achieve the efficiencies of a manufacturing operation are more likely to be successful.

Robust and reliable supply chain

Produce has a shelf life. So, when you grow produce, you need a destination for it. Vertical farming offers a more predictable harvest and a more dependable product stream for the supermarket, supplier, and buyers.

Whereas growing outdoors, a cloudy week during the initial growth phase can disrupt your harvest for weeks. With vertical farming, you can stagger production and make it repeatable. This systematic approach to farming means you can offer the right quantity of lettuce every week.



So what's holding vertical farming back?

Let's look at eight aspects of vertical farming we need to solve to make it a reality.

1

GROWING IS EASY, BUT WE NEED TO GROW AT SCALE.

To grow, we need water, light, and nutrients. To reach a profit margin where a head of lettuce or a bell pepper costs what people expect to pay, not 8 dollars, we have a long way to go. Never mind that it's organic, free of GMOs, free of pesticides, doesn't need to be washed, or grown locally, vertically-farmed produce needs to be available at an acceptable price point to catch on. No one today is at that scale. ☹

To make vertical farming profitable, we need to scale up. Growing five plants at a time, or 500 is not the same as growing 5,000 or 50,000.

2

AUTOMATION NEEDED

A good deal of vertical farming technology already exists. We can size the pumps, we can flow water, we can measure and supply nutrients. But to make vertical farming work at scale, we need a lot of automation. The future of vertical farming is a factory where the technology for seeding, watering, harvesting, getting rid of bad plants, and packaging the good ones for sale runs with little human intervention.

We can port over the robotic tech from the traditional food and beverage space. Automated harvesting, say chopping

lettuce, already exists. But to harvest indoors and keep our plants living and regrowing, we need more sophisticated technology. We don't yet have tech that can pick tomatoes from a tomato plant without tearing it apart.

3

COMPLEXITIES AND DISEASE

Plants are as easy to grow as they are easy to kill. Tending to 10 plants in a container-sized indoor farm is one thing. Tending to 10 different grow rooms with various plants at different growth phases is another. Even indoors, plants are susceptible to disease. Threats to growing plants are magnified greatly when we keep them in the same confined space. A bad batch of seeds or the wrong nutrient mix can wipe out an entire harvest. We have a lot to learn.

4

A HUGE APPETITE FOR POWER

Growing plants indoors requires specialized lighting. Even the latest LEDs consume a significant amount of power. To grow indoors, we need nice, moist, humid rooms. We need to take moisture out and provide it when appropriate. Thus, HVAC units are running almost 24/7 in these giant controlled spaces. The very tight temperature tolerances we need to ensure that the plants are ready for harvest drive the cost of these food factories.

The building infrastructure for a vertical farm is not complicated. We can start with the shell of a building, a warehouse space, or a purpose-built industrial building. But all that power must be supplied by the local municipality. The scaled-up vertical farm is going to ©



pull hundreds of megawatts, so finding the right community partner is crucial.

However enthusiastic a local government might be for a large vertical farm; it may not have the power infrastructure in place to support its intense power needs. It may take years for a community to develop the requisite power infrastructure.

5

INSATIABLE THIRST

Traditional outdoor industrial farms collect and use a great deal of rainwater for irrigation. The vertical farm on the contrary must use “boutique” water, processed water pumped full of nutrients to give the plant exactly what it needs in place of what it would draw from the soil. A large-scale vertical farm consumes millions of gallons of water.

Someone must clean up that water and process it so it can be used again—recovery is sometimes dictated by the municipality. So, the large-scale vertical farm has significant wastewater system needs. It also has options in how it approaches

water treatment and reuse. For example, the vertical farm operator might consider deploying systems to treat its own water, perhaps recouping some nutrients and water in the process. Here there may be opportunities for the vertical farm to achieve efficiencies that benefit the bottom line and make it a welcome neighbor.

6

REPEATABILITY

To achieve repeatability that’s necessary to create a quality product in this facility and harvest a great bell pepper or purple carrot every time, we need to process engineer the factory for consistent inputs and outputs. Each plant requires the same nutrients, the same water flow, and the same climatic conditions.

Taking a close look at the growing zone, we see some thorny issues. How do we guarantee that the plant closest to the process pump or reservoir is not stealing all those nutrients? How do we make sure that the plant at the very end of your growing tray is getting what it needs? If we can devise affordable engineering solutions

for these questions, we will unlock large-scale vertical farming.

7

SELECTING SYSTEMS FOR PEAK PERFORMANCE

System selection can make the difference between a viable business and a money-losing large-scale vertical farm.

Will one giant HVAC system suffice, or do you need 10 smaller HVAC systems each assigned to a unique growing zone? Which system best achieves the need to grow plants, the need for efficient operations?

A vertical farm opening to operate at scale isn’t exactly flexible. It has highly specialized systems. Consider that HVAC unit, for example, because it is rated for a room with 50,000 plants. If your start-up opens that room with just 20,000 plants, the unit will be off its performance curve. We will need to fine tune rooms for a specific crop. This presents another challenge for launching vertical farming at scale, but there may be innovative, even modular approaches we can engineer that allow for a multi-stage scaling up. ☺

MARKET NEEDED

Say we can build a vertical farm to scale. We need to be profitable to survive. Who is buying and where are they?

To make vertical farming work, we must connect it to a robust supply chain, a market that can take on product right away and sell it. Can we get 50,000 plants to 1,000 grocery stores which will sell them before their shelf life comes up?

We need to be able to sell the produce in a timely manner—because the profit margins are so slim. Partnering with farm shares, major retailers, and more are the pathways to building stable, reliable demand. This is where location comes in. Large-scale vertical farming will need to serve major metro markets to succeed. We will need to build them in proximity to existing produce transport systems.

To launch vertical farming at scale, we'll first need to engineer solutions for all these issues above. Someday we will grow a great deal of our food indoors. It's just a matter of *how soon*. 

✓ [RETURN TO TABLE OF CONTENTS](#)

MORE FOOD & BEVERAGE

Brian McClelland is a process engineer based in Burlington, MA. He has experience in process design, commissioning support, R&D partnership, vendor and client management, regulatory compliance and value engineering within the food & beverage and biopharmaceutical industries.



CUTTING DOWN ON *CUT*
& **PASTE**

GeneSys takes the repetition out of conceptual engineering design.

BY OLIVER VILÉ

WHAT IS GENESYS?

GeneSys is a proprietary engineering design and markup platform that speeds up the conceptual design phase, reduces errors, and optimizes our team's unique skillsets. The core concept is that engineers can perform quick and easy document markups in an intuitive user interface and automatically perform their engineering calculations in the same spot—rather than relying on cumbersome copy-and-paste to move between different tools. More than this, however, GeneSys takes the data from the model the engineer creates and makes it live and usable elsewhere. Stantec's Buildings Digital Practice is continuing to expand the GeneSys platform with new 'toolsets' for engineers tailored to their specific workflows.



LEARN MORE ABOUT OUR **DIGITAL PRACTICE**
TEAM AND DIGITAL SOLUTIONS

WHAT PROBLEM DOES IT SOLVE?

A great deal of the workflow for buildings engineers in early design stages is laborious. It involves an engineer tracing PDFs in Bluebeam (an app for working on PDF files) and then manually transcribing that information into a spreadsheet or into an analysis model. The engineer can then run calculations based on that information. It's awkward, unwieldy, and inefficient.

It's worth noting that we strive to build customized tool sets for the workflow engineers use daily instead of building holistic engineering design software to suit everyone. So, we look at the exact workflow required and build fine grained, bespoke tools that help our people do their jobs more efficiently.

The result is GeneSys, Stantec's cloud-based engineering system solver. GeneSys turns that markup task into a powerful cross-platform data-rich modeling process. This web-based app allows our engineers to generate 3D models from markups, automate complex engineering calculations, and export the model and data into other design and modeling tools seamlessly. GeneSys is not constrained to one discipline or workflow. It's a flexible platform.

HOW ARE WE USING IT TODAY?

1 We built a GeneSys toolset for engineering mechanical ductwork (air conditioning/heating/HVAC).

The current workflow is extremely tedious, requiring our engineers to mark up each duct on a PDF, measure lengths, manually input the data into a standalone "ductulator" calculation tool, then solve for the dimensions of every duct manually before importing that data into either Revit or a spreadsheet.

With GeneSys, the user uploads the PDFs, draws their duct layout, and hits the "solve" function. The app sizes all ducts to the appropriate national codes and standards. GeneSys also calculates air pressure drops throughout the duct network which is necessary for choosing an appropriate fan size. ☺

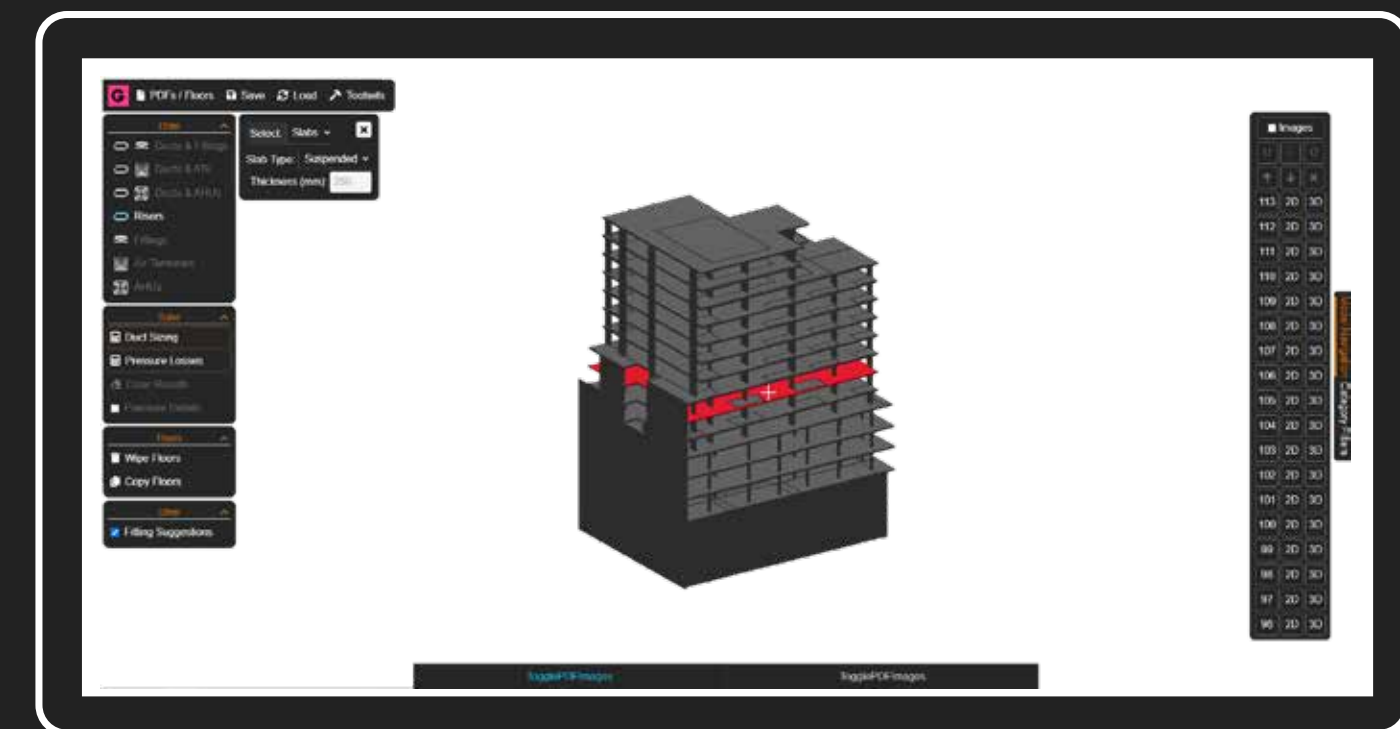

2 We built a toolset for modeling building structures.

Similarly, structural engineers markup structural elements in Bluebeam, declaring where columns, beams, and walls should be located, but that document is static. To bring that design data into the realm of BIM (building information modeling), the modeler needs to reinterpret the shapes, markings, and color coding from the static document and build a Revit model from that manually.

In the new workflow, the engineer marks up the structure in GeneSys and gets three model options at the click of a button: they can produce a Revit model, an Etabs model, or a SPACEGASS model—those last two are analysis software platforms for structural engineers. Thus, for the same engineering labor cost, from marking up a set of PDFs the engineer gets three different models that ordinarily would have taken days to weeks each to create. The enhancement makes our teams more efficient and allows them to leverage their design skills and explore opportunities for innovation versus gobbling up time and resources with tedious processes.

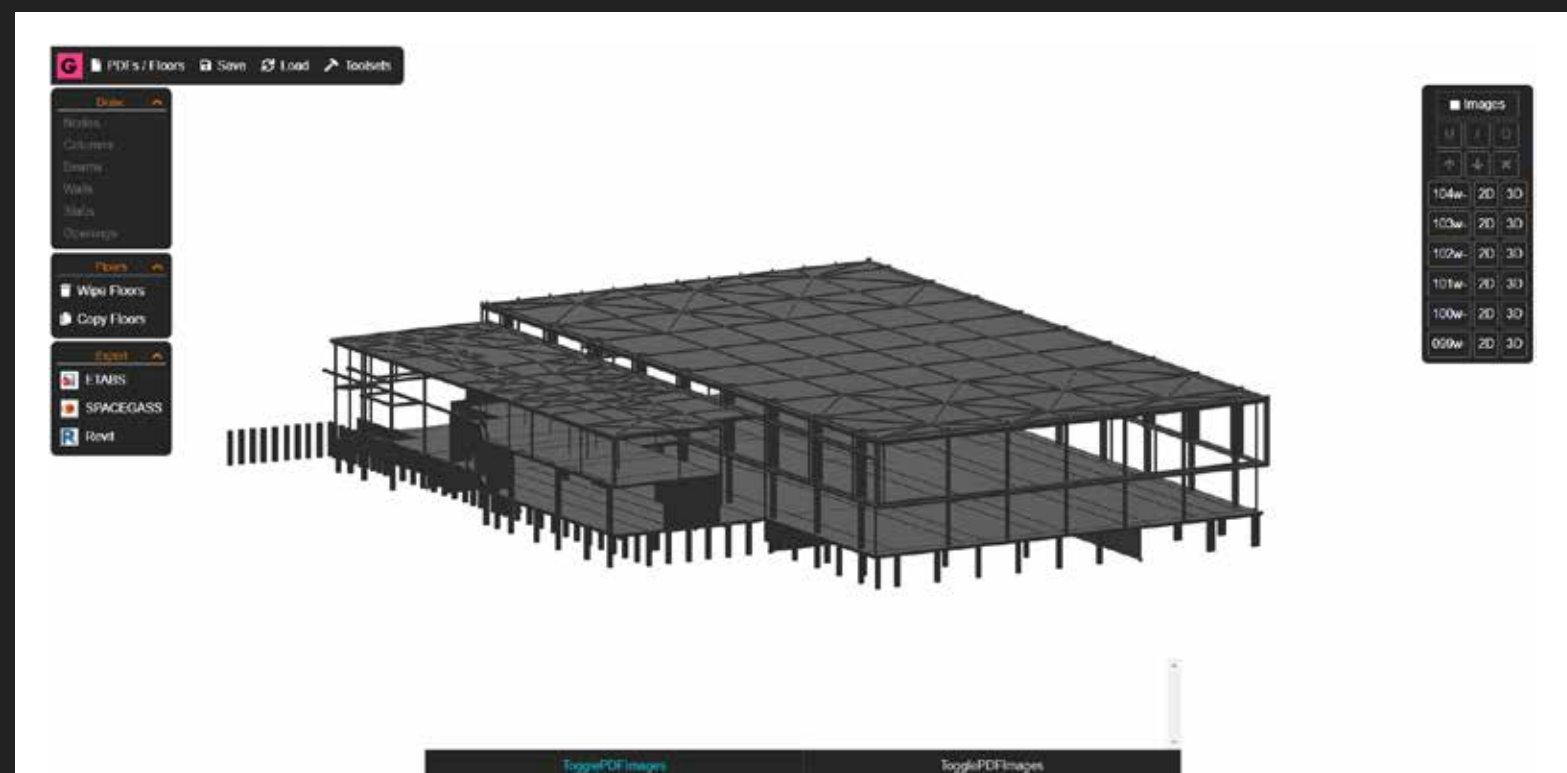
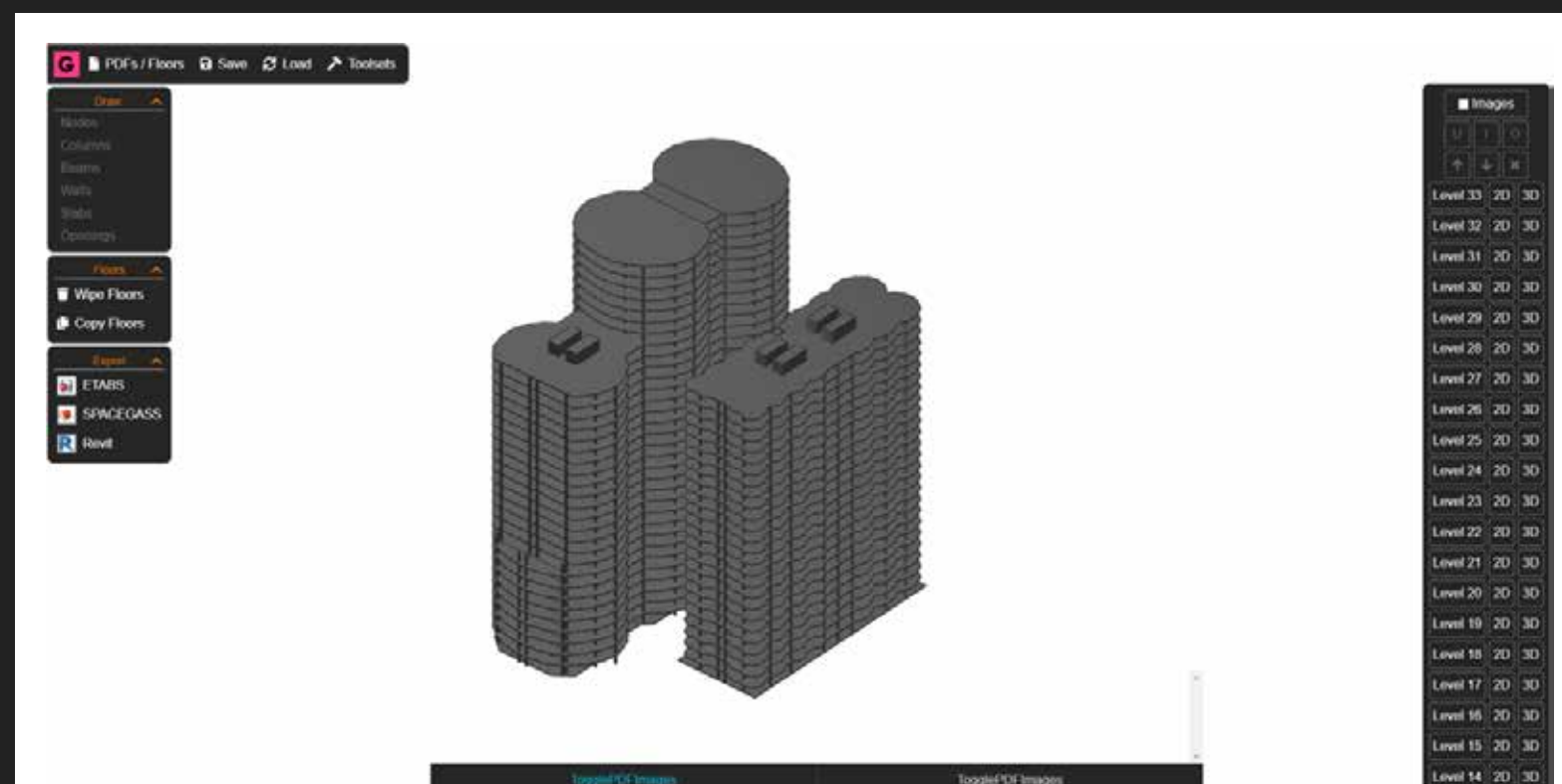

502 Albert St, East Melbourne, Victoria

16-level hotel tower incorporating existing 120-year-old old masonry façade at lower levels

STATUS
Under construction

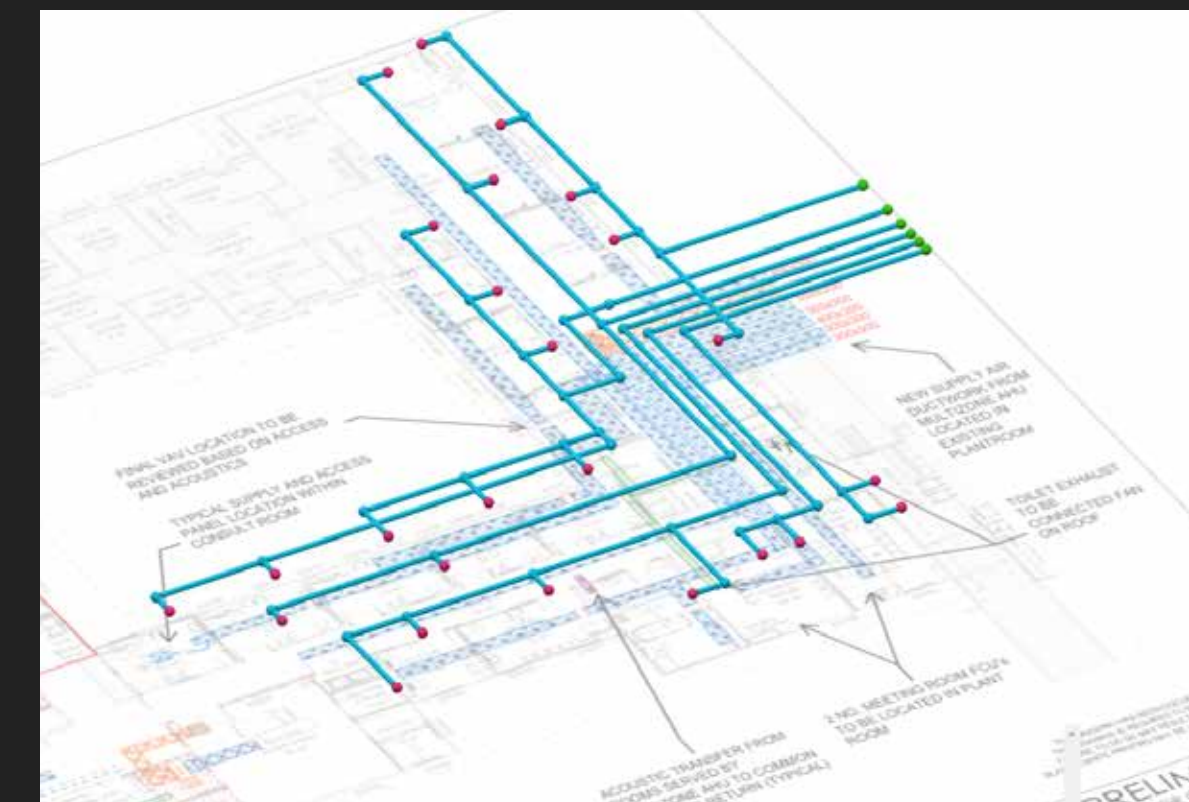

Queensberry and Bouverie towers Melbourne, Victoria

Two towers (one 33 levels, one 26 levels) on inner city block. One tower for social housing and student accommodation, one tower as build-to-rent

STATUS
Planning phase

3 GeneSys's capability builds on similar tools for sizing cold water pipework and other tasks we built in its predecessor.

In this workflow, hydraulic engineers draw their water supply lines, fixtures (basins, toilets, showers), pumps and valves in sketch form onto PDFs. GeneSys sums all flow requirements of fixtures and size all pipes according to one of several solver methods and industry standards. The automated workflow saves an engineer time compared to measuring lines manually in Bluebeam then sizing each pipe one by one via a static lookup table, calculator, or Excel. GeneSys also generates schematic diagrams for engineers to review. We are working on a similar toolkit to support mechanical pipework design. ☺

Sports and Aquatic Centre, Burwood, New South Wales

Large span structure over concrete floor level to suit 4 basketball courts in a mixed-use building

STATUS
Under construction

4 GeneSys can create acoustic simulation models.

The simulation software our acoustic engineers use lacks a user interface for creating geometry. Users must manually type out a text file of coordinates, and line and plane connectivity. Using GeneSys, engineers can draw space geometry and assign acoustic surface treatments from a library and export the simulation model file automatically, saving them significant time.

5 We are currently working on a toolset for creating electrical building models (lights, wiring, conduits).

A significant pain point for engineers in the current process is that when they markup electrical elements (lights, power points) on PDF a Revit modeler must re-interpret this drawing and manually create the elements in the Revit model. We are currently developing a tool in GeneSys to connect electrical markups with Revit models. In GeneSys the engineer's markups can be directly imported to Revit, saving time and reducing errors. ☺

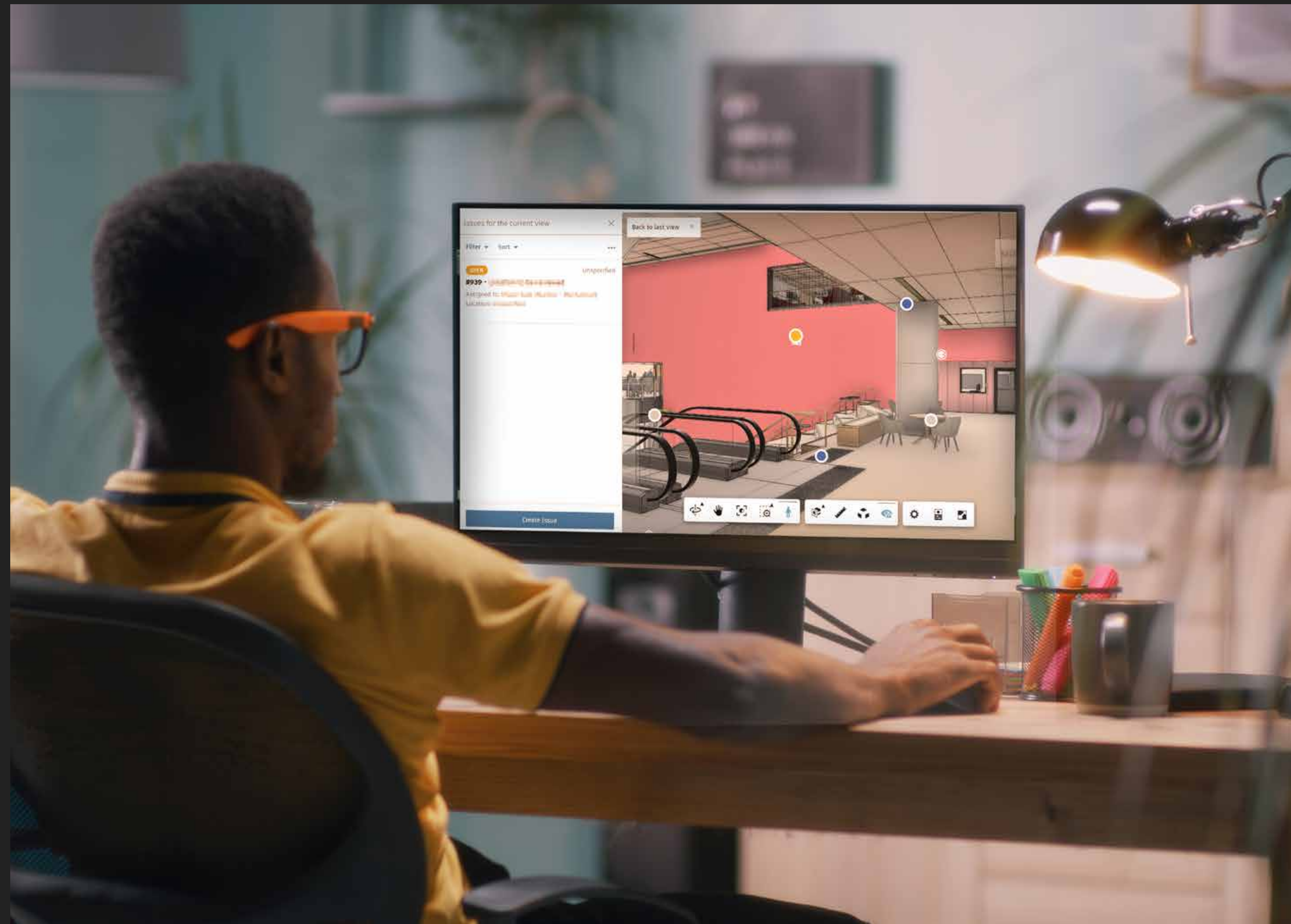

HOW TO USE **GeneSys**

1. BEGIN WITH A MARK-UP

Any level engineer can sketch over reference material in 2D or 3D to generate a concept-stage/ schematic solution.

2. RUN A SOLVER

GeneSys provides a series of toolkits and solvers that apply themselves to the mark-up, immediately integrating heuristic to complex engineering calculations.

3. EXPORT

GeneSys can export to PDF, Revit, and other software programs as requested by practitioners. It can generate schematic diagrams.



THE BENEFITS

We're targeting the conceptual design phase where the name of the game is to get your results as quickly as possible so you can test several designs quickly. From the engineer's perspective, the main value of a tool like this is in being able to iterate faster in the early design stages. Fundamentally, it is a time saver, but it also reduces errors in complicated workflows involved in transferring data from drawings. We're also looking at building GeneSys' solvers as Revit plug-ins to empower our engineers in that environment and during the detailed design stages.

Increasing the efficiency in our engineering workflow and automating repetitive tasks translates to improved quality and improved coordination. It allows our engineers to spend more time focusing on our clients' big picture goals for sustainability, flexibility, resiliency, and modularity. It's about shifting high value time toward efforts that require qualified engineers to solve problems that advance client business goals. 

✓ [RETURN TO TABLE OF CONTENTS](#)

MORE BUILDINGS ENGINEERING

Oliver Vilé is an application developer with Stantec's Buildings Digital Practice team in Stantec's Melbourne, Australia office. He builds flexible tools to enhance workflow for architects and engineers.

**Williams
Landing Town
Centre**
Melbourne, Victoria
*Architect: Case Meallin
& Associates*



PROTECTING DESIGN INTENT

Can emerging delivery processes
result in better hospitals?

BY SUZANNE CRYSDALE

Through the P3 (Public-Private Partnership) model, Ontario has been delivering critical public infrastructure, like hospitals, highways, and transit facilities for more than 25 years. Government adopted the P3 delivery model to transfer the financial and project risks associated with large public projects to the private sector. Like any delivery model, there are pros and cons to the delivery process such as maintaining design intent, infusing community participation, creating space for innovative solutions to emerge, and most importantly achieving value with dollars spent.

After two decades of use, there have been many lessons learned by all participants in the P3 delivery process and continuous improvement of those processes has inevitably led to the emergence of a new delivery model. ☺



**All images:
The Peter Gilgan
Mississauga
Hospital (TPGMH)**
Mississauga, ON



Typically, when we're engaged as the planning, design, and conformance (PDC) consultant for traditional P3 healthcare projects in Canada, we create an illustrative schematic design (ISD) and project specific output specification (PSOS) for builder/contractor teams to bid on in an open request for proposals period. Those teams include architects and engineers who are subconsultants to the builder/contractor. Proponent teams (comprised of a general contractor, architects, engineers, specialist consultants, financier and sometimes building operator) examine every aspect of the design and put it back together again, sometimes in newly proposed configurations, to formulate a bid for the client.

3x

THE SIZE OF THE
CURRENT HOSPITAL

23
stories

MAKING IT THE FIRST
HIGH RISE HOSPITAL IN
CANADA

950 beds

DRAMATICALLY
IMPROVING THE ABILITY
TO PROVIDE CARE TO
THE COMMUNITY

In the case of **The Peter Gilgan Mississauga Hospital (TPGMH)**, a project we are currently working on, we are applying a different model. As the PDC architect, we spent two years in user engagement and consultation with clinicians and doctors at the hospital while engaging authorities such as the City of Mississauga. This extensive period of deep user and community engagement informed us as we created the design for TPGMH. We want to preserve the influence of this engagement on the design.

Halfway through our design for the new Peter Gilgan Mississauga Hospital, our client decided to implement a relatively new procurement method called the progressive delivery model or PDM.

In the PDM, the design and bidding activities take place in parallel rather than sequentially. The client goes to the market with a request for proposals while the PDC team is developing an illustrative schematic design and project specifications. This way the client can release drawings with a clear design direction which the competing teams of builders can use to generate a price and implementation schedule for their bid. ☞

We continue our design in the background side-by-side with the competition as opposed to the linear process where we would have finished our design before the RFP open period in a traditional P3. The purpose of the RFP in the new progressive delivery model is to pick one proponent rather than three that you typically have in a Design-Build-Finance (DFB) or Design-Build-Finance-Manage (DBFM) P3 models. Once the RFP has closed, the designer works with the winner, the first negotiated proponent (FNP).

Once selected, the FNP brings forward opportunities to find value, improve constructability, and save time and money. But in this collaborative model the teams work together. The PDC still supports the client side and is there to protect design intent and client vision while the FNP is looking for opportunities to drive additional innovation and best value for money.

Best of both worlds?

The goal of this progressive model is to get the best of both worlds from the design and construction process. The model spurs collaboration and gives the PDC team an opportunity to preserve the innovative elements and stakeholder needs integrated into the design, while giving the builders the incentive to keep the project on budget and schedule.

The overlap of the RFP open period with the ISD phase gives the team access to valuable constructability and procurement feedback early in the design phase. While no model is perfect, the PDM is proving to be a beneficial procurement model for THP's new hospital where it has shortened the overall project schedule. ☺

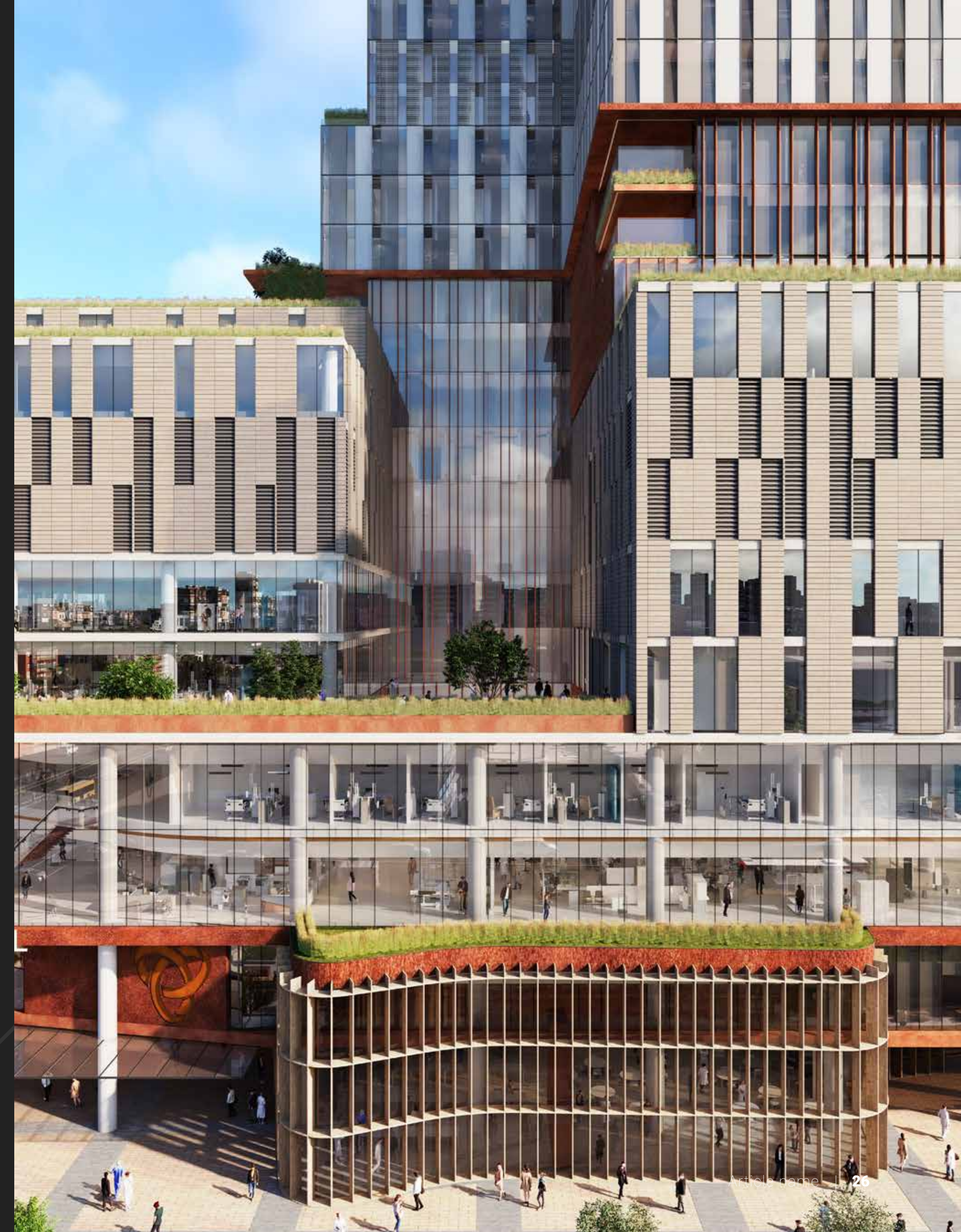

Design as exemplar

Another aspect of The Peter Gilgan Mississauga Hospital project differentiated it from business as usual. On TPGMH, our clients, Infrastructure Ontario and Trillium Health Partners, supported an “exemplar” design for a majority of the departments and site planning to preserve the influence of user engagement and maintain forward momentum for this critical public infrastructure project. This means, when we begin to collaborate with the builder group and their consultant team, they will be starting their work with the design developed by the PDC team, rather than unraveling it and starting over.

The goal is to protect the client’s design priorities, as well as the extensive user engagement and community input we’ve already designed into the project.

This new approach helps drive increased levels of flexibility, digital enablement, health and wellness, and inclusiveness as part of a whole hospital design which emphasizes the patient experience. ☺



An outdoor terrace at the juncture between the podium and tower provides patients, caregivers, and family the opportunity to connect to nature.



Floor-to-ceiling windows in inpatient rooms exemplify design which prioritizes light and views for patients, family, and caregivers.



The light-filled lobby provides a vibrant urban realm at grade, connecting people to each other and to the community.

Ideally, this collaborative process protects the design intent and user input and results in a better, truer design. Re-engagement isn't necessary which should save the client time and money. The big payoff is that it should result in a built environment that is a better fit for the community.

By advancing the project with a design exemplar and setting the stage for a collaborative approach, we can avoid some of the pitfalls of prior P3 models where cost could trump critical design criteria. The optimal result will be a hospital that looks good, functions well, and is delivered within the client's design and construction budgets.

A hospital should be a place for healing. The spaces need to be a dignified place for the people receiving treatment and also for hospital staff. This PDM model enables us to deliver elevated design while making effective use of public dollars. ☺

THE ALTERNATIVE DELIVERY

PERIODIC TABLE

Today, there's more than one way to get a building built.

BY TARIQ AMLANI

DBB

DESIGN-BID-BUILD

In a conventional Design Bid Build project, design and construction proceeds in a linear fashion with separate contracts for the designer and the contractor.

DB

DESIGN-BUILD

In DB, the owner hires a team to prepare an RFQ/RFP to solicit contractors. Contractors, with a team of designers and sub-contractors, bid on the project and present a schematic/conceptual design at the bid. The owner enters into a contract with the builder's team. The contractor manages the team with design and construction happening concurrently. The owner's team monitors contract compliance.

CMAR

CONSTRUCTION MANAGEMENT AT RISK

In the Construction Management at Risk model, a construction manager (CM) joins the project team during the design process. Contracted directly by the owner, the CM provides early advice on constructability, trade and product availability, project costing, and scheduling. As the design team develops the packages, the CM tenders them out to the market on behalf of the owner. Once the design is developed to a level of certainty, the CM provides a gross maximum price (GMP) to fix the total project cost, and the contract is converted to a fixed price/schedule contract.

DBF

DESIGN-BUILD-FINANCE

In a Design-Build-Finance delivery model, a Planning, Design and Conformance (PDC) team is engaged to create an illustrative design and project-specific output specification which guides competing Proponent teams comprised of a General Contractor, Design Consultants (A/E), and Financer to prepare competitive bids based on a net-present value for a project. Typically, the lowest net-present value team is selected to further develop the design from the design development phase into contract documents and construction.

DBFM

DESIGN-BUILD-FINANCE-MAINTAIN

Design-Build-Finance-Maintain is identical to DBF, but also includes maintenance (not clinical) services over the concession period for the contract (typically 30 years).

IPD

INTEGRATED PROJECT DELIVERY

IPD is built on shared responsibility where profit for builder, designer, and key subs is "at risk" along with the client's primary construction contingency budget. IPD focuses on efficient and lean processes with an emphasis on quality-based selection of construction and consulting firms.

ACM

ALLIANCE CONTRACT MODEL

The Alliance Contract Model is similar to Progressive Design-Build in that it delivers capital works projects using a collaborative approach between the public sector (the owner) and the private sector parties (non-owner participants). In an Alliance, the owner and contractor project staff are fully integrated and both parties share risks and responsibilities equally and make unanimous principle-based decisions on key project issues while achieving improved project solutions. The ACM model guarantees the consultants and contractors their direct costs, and puts their profit and overhead at risk based on team performance.

THE PETER GILGAN MISSISSAUGA HOSPITAL (TPGMH) WILL BE THE

LARGEST HOSPITAL IN CANADA.

The Peter Gilgan Mississauga Hospital is a historical redevelopment and full replacement of the existing hospital. It is part of Trillium Health Partners' plan to build an **interconnected system of care** to meet the health needs of its growing and diverse community for the decades ahead.

Scope

TPGMH will be almost **triple the size** of the current hospital at 23 stories, approximately 2.7 million SF of space, with 950 inpatient beds.

TPGMH will increase operating room capacity by 40% and feature the largest emergency department in Ontario, lowering wait times and improving patient outcomes.

✓ [RETURN TO TABLE OF CONTENTS](#)

MORE HEALTH

Suzanne Crysdale is an architect and project manager based in our Toronto office leading teams on many of Stantec's largest and most complex health projects.

Tariq Amlani is a mechanical engineer and healthcare leader based in Stantec's Victoria, BC office.

Collaboration

Stantec's design process for TPGMH included years of engagement with close to **40 different stakeholder groups**.

Landmark

The new TPGMH will be an **urban landmark and community hub** reflecting Mississauga's multicultural and vibrant nature. It connects with the surrounding communities and is located along one of the city's busiest streets—Huron Street—which connects Mississauga's waterfront with downtown and three major highways.

Approach and landscaping

We thoughtfully designed the hospital to connect to the ground plane and the surrounding landscaping and pedestrian approach to the building and public realm.

Maintaining operations

The challenge for our team at TPGMH was designing a **new vertical hospital** on a sliver of land, so that it could be built without disrupting the existing hospital which needs to stay open until the new facility is operational.

Global team

We began this project during the pandemic, so it's been a **virtual collaboration**, and a real success story. We drew our team of experts from Toronto (ON), London (UK), Philadelphia (PA), Chicago (IL), Washington (DC), Calgary (AB), Vancouver (BC), Auckland (NZ) and elsewhere. But from our client's perspective, it's been a seamless collaboration with one integrated design practice within Stantec. 



Main lobby/cafe



The
future OF design
a conversation

We brought together two of the many lively minds in Stantec Buildings to discuss the future of design. John Dugan asked the questions.

BY MICHAEL BANMAN AND DAVID MARTIN

Q Today's articles about the future of design are either about how technology will change the design profession, or about which problems design can solve and how. Are those two valid ways of looking at the future of design?

MICHAEL BANMAN: In design and construction, you have technique influencing how ideas and materials come together, and then you have issues or challenges. But I would argue that these two influences, technique and challenges, have always advanced design.

Architecture reflects culture while simultaneously advancing it. Architecture responds by using, creating, or advancing technology or technique to address whatever those issues might be. Today for example, some of our most pressing issues include climate change and our response to the issues surrounding

sustainability and resilience, coupled with our humanitarian crisis, as well as social issues, such as affordable housing, equity, diversity, and inclusion. After decades in the wilderness, architecture is once again engaging with technology to try and address the issues of the day.

DAVID MARTIN: In the book *The Future* by Nick Montfort, he makes the point that the future is not something you can easily predict. It's something that gets made. We can try all we want to predict what's next, but we need to be careful. There are going to be a lot of surprises within each 7-year innovation cycle.

It's impossible to resist imagining the future because it's fun. But there are wildly different ways of looking at it. The Royal Institute of British Architects (RIBA) here in the UK in conjunction with the American Institute of Architects (AIA) did a survey of architects and engineers, and the top five value statements about the future of design had to do with social values,

The history of innovation cycles

Below, we show waves of innovation across 250 years, from the Industrial Revolution to sustainable technology.

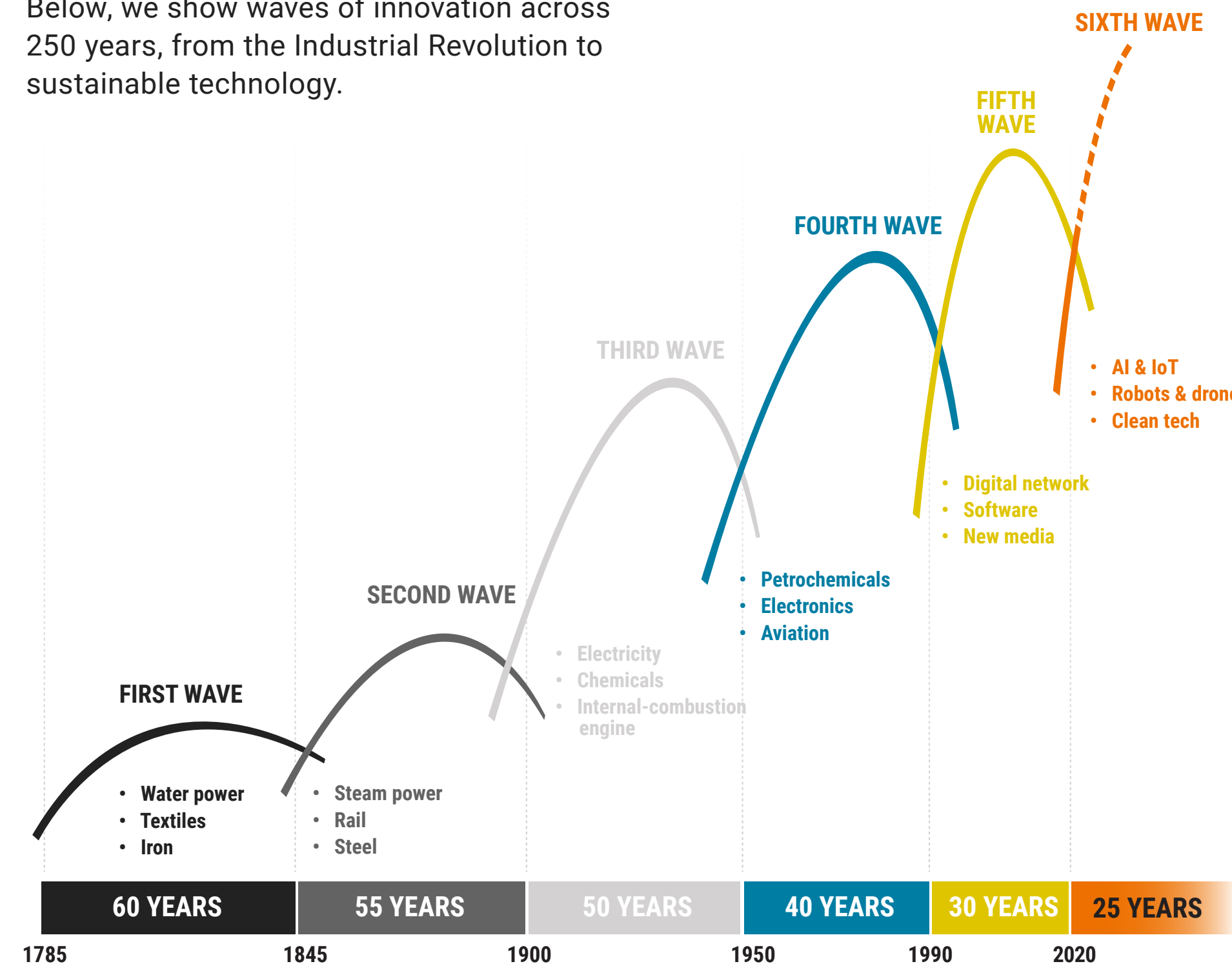

Source: Edelson Institute

climate change, and carbon. Those surveyed thought these were the critical things they needed to manifest in the design process and our design outcomes. Now contrast this with the future of design as the major consultancy firms talk about it. They are fascinated by the impact of technology, and what that's going to mean to the profession.

For Stantec, some of them connect. We think most things on both lists are important. And our strategic plan shines light on some of them.

When I think about the future of design, I think about job titles for roles in design that don't yet exist. Who's going to be the artificial intelligence (AI) manager on our team to make sure the robots don't take over and put us out of a job—to ensure we use AI safely with purpose? ☺

Q **How is the role of the architect changing?**

DM: I saw a talk about the role of the architect recently which compared Filippo Brunelleschi, designer of Il Duomo in Florence with Leon Battista Alberti, who came after him. Brunelleschi represented a time when the role was all-encompassing. The architect was making decisions and directing construction for buildings centuries in the making, a true master builder and architect, while Alberti created the façade and left the details to others. Today, in many places architects are forbidden by law from prescribing means and methods of construction. Elsewhere, in the Middle East it's a contractual requirement. In southern Europe, architects might graduate equally trained in engineering.

So, some are projecting a future in which the architect will reclaim the former expanded role and take a more Brunelleschi approach. Others say no, we're going to do schematic design because in a decade or two we'll have new technology that will complete the working drawings. Thus, our role will become more about conceptual steering and less about production.

Design doesn't stop at the conceptual stage; and the fine crafting of materials and space, along with architects' unique ability to integrate formalism and creativity will remain at the heart of our role. Will AI and other technologies really be able to replicate this?

MB: In western society, it's about litigation and risk mitigation. There's a Joshua Prince-Ramus TED Talk where he says that where there is liability, there is power. Whoever embraces the risk or takes on the responsibility, has power. If you back away from risk and responsibility, your influence will be diminished in equal parts. Society is just now putting things

back together; we are once again demanding a more holistic approach. An integrated design practice, like Stantec, is perfectly positioned to advance design by bringing together all the allied disciplines, using and advancing technology and technique, to address complex, multi-faceted issues, such as climate change or social challenges through our fully integrated practice. But we need to embrace that holistic thinking.

I agree with those that say as architects our duties and responsibilities need to expand in response to the issues, challenges, and problems we face today. Some people might think that architecture is solely about the way things look. The truth is that we're good critical thinkers and good problem solvers, able to think strategically and tactically at the same time considering a vast range of variables and constraints. And if society is going to put things back together and think holistically, we need to take advantage of this unique skill set, and that would suggest an ever-expanding role for architects. ☺



Virgin Hotel
New York City, NY

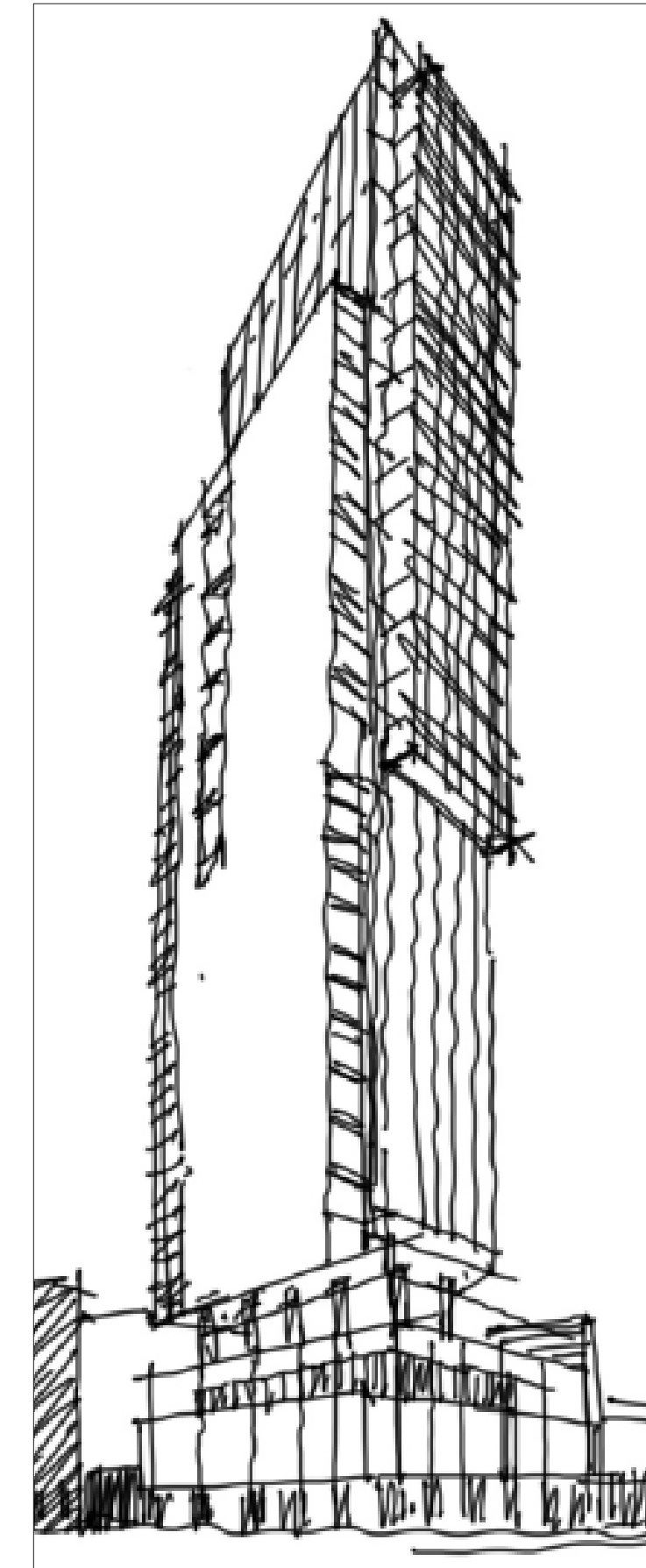



What about the influence of technology?

DM: Technology is on this huge arc so it seems like it should be easy to solve problems with automation. The challenge is that the problems are also on a similar arc. The problems we're trying to solve as designers are much more complex, even if they don't take on the burden of societal change or larger global climatic issues.

MB: One thing we need to be cautious about is innovation for innovation's sake. This is not a good use of time. How do we improve things? How do we make things better? That has to be the fundamental question: how to do what we're doing better, not just different? Too many architects are trained to believe that different is better when in fact it might not be. Sometimes different is just different.

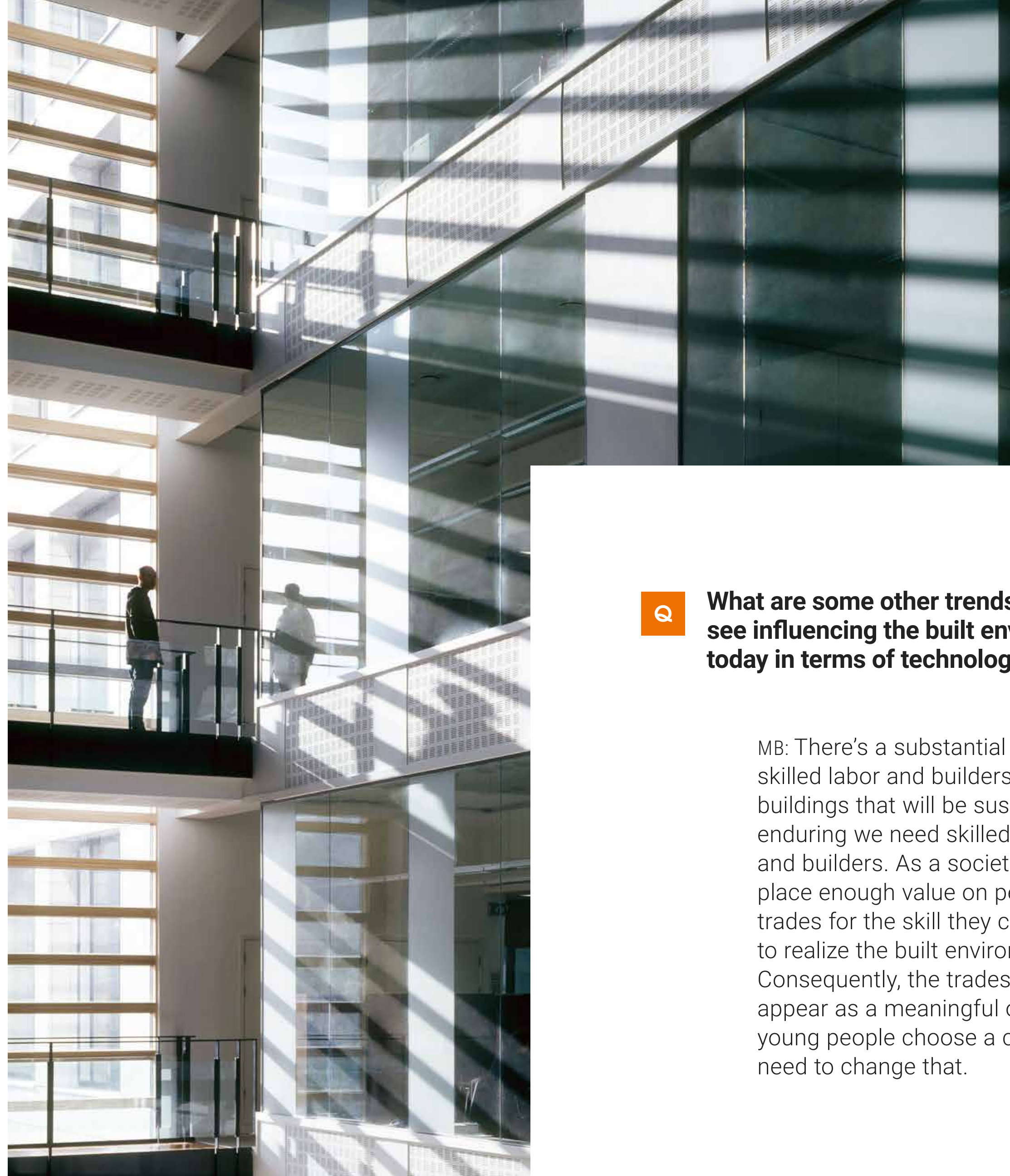

What are some other trends you see influencing the built environment today in terms of technology?

MB: There's a substantial shortage of skilled labor and builders. To build buildings that will be sustainable and enduring we need skilled trades and builders. As a society we don't place enough value on people in the trades for the skill they contribute to realize the built environment. Consequently, the trades may not appear as a meaningful option when young people choose a career. We need to change that.

On the other end of the spectrum, we're seeing an increasing employment of robotics and automation in fabrication to prefabricate parts for faster assembly on site. This is revolutionary for building with mass timber, where fabricators can machine columns, beams, floors, walls, and roofs like a Meccano set, for assembly on site.

DM: We will have a growing number of tools in the digital environment which will integrate AI and help us as designers. AI will rapidly integrate into management systems, too. Material ecology and living facades will evolve with AI support. I'm very curious about 3D printing habitats as building components or printing biopolymers to replace plastic. I'm looking to those who are pushing the envelope in nature-centric design like Professor Neri Oxman at the MIT Media Lab. She and others like her are advocating for an architecture which 'grows' within natural systems as a 'must do' for survival. She's researching bees as the inspiration for a fleet of mini-robots to build structures on Mars. ☺

Systems thinking

The built environment is part of a complex, interconnected world—its social, ecological and economic systems. Systems thinking purposefully analyzes the links between stakeholders, forces, and innovations to help us solve increasingly complex challenges.

Buildings

*Interiors
Core and Shell*

Public Realm

*Parks / Streets /
Greenspace*

Infrastructure

*Streets / Roadways /
Bridges / Sewers*

Rivers

Below Grade Infrastructure

Storm water

Waterfront

*Ecology/ Access /
Resiliency edge*

Urban Storm Watershed

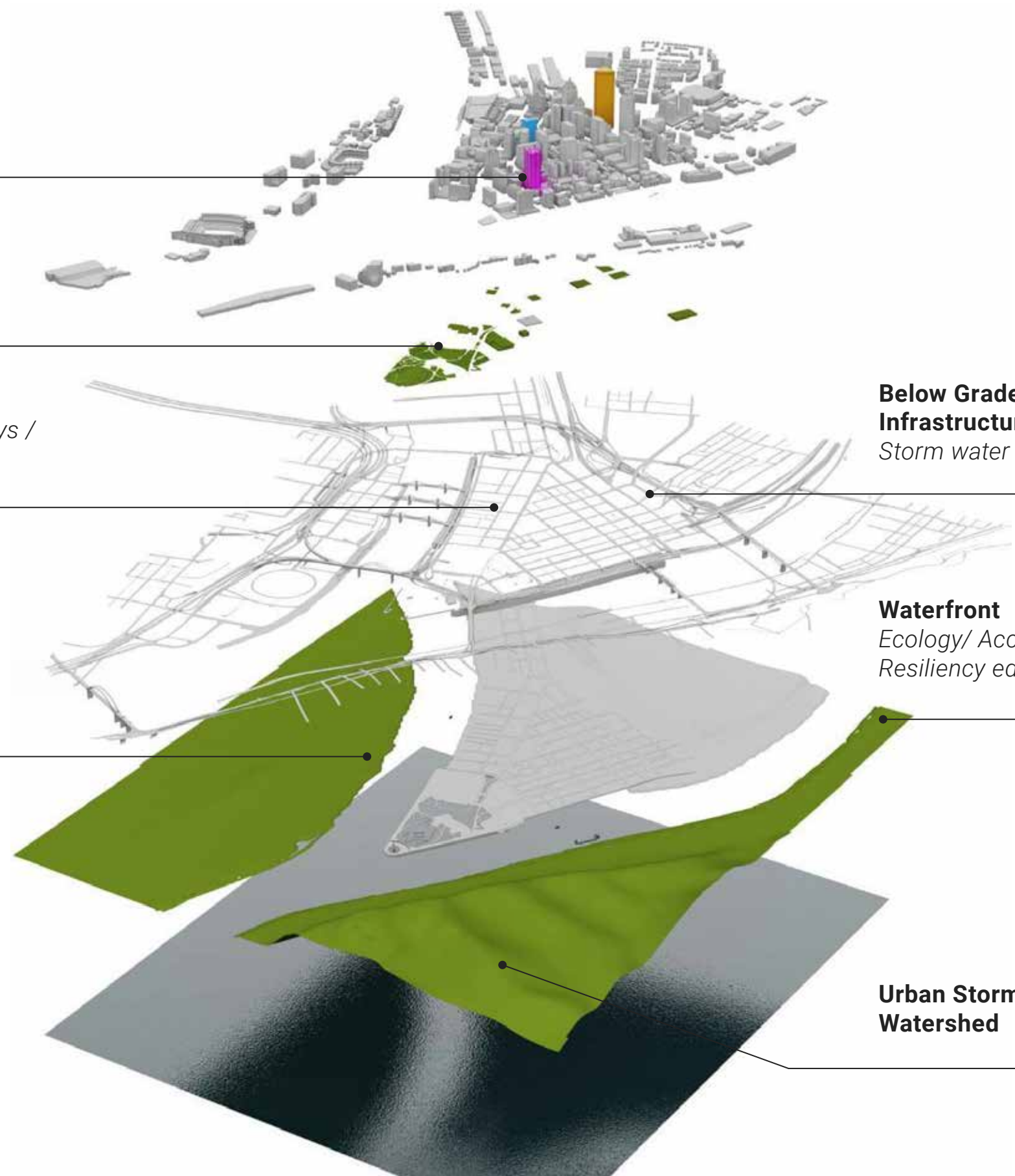

Q How do architects show they belong on the team to solve bigger problems? How do they get a seat at the table?

MB: Look at business schools around the world, they are adopting design thinking as a way of training and educating students. What's design thinking? Design thinking is thinking the way architects think and have been trained to think and work since the beginning. Schools are adopting design thinking and applying it to other disciplines. Another example is healthcare where they're taking an interprofessional approach to treatment—creating a holistic approach to health and well-being. That whole approach is the way that architects fundamentally work.

Architects are trained to think holistically, to think about the big picture, how all the different pieces interact with each other and fit together.

The more information we receive early on from our clients, from engineers, from the authorities, from the manufacturers, the better we can do our work.

Today we rely on partnerships with the allied disciplines. However, the practice of architecture remains fundamentally the same, to work through all the different variables with people to find complete solutions to those issues, problems, and challenges, not just to make it look a certain way or to address one small aspect of the building code or construction. The role is to take all of it into consideration, working with everyone at the table, and deliver something that performs and inspires, with clarity and vision, that addresses all those complexities while creating a net positive impact on the community it serves.

DM: Ray and Charles Eames put together a [diagram](#) in the sixties. It's not lost any salience in the intervening years. The diagram describes design as being the intersection of various forces and factors and the interests of the designer. It says that sweet spot is when the designer's interest intersects with the client's functional needs and society's "concerns as a whole." Right in the middle where they all overlap, that's where you achieve true greatness. ☺

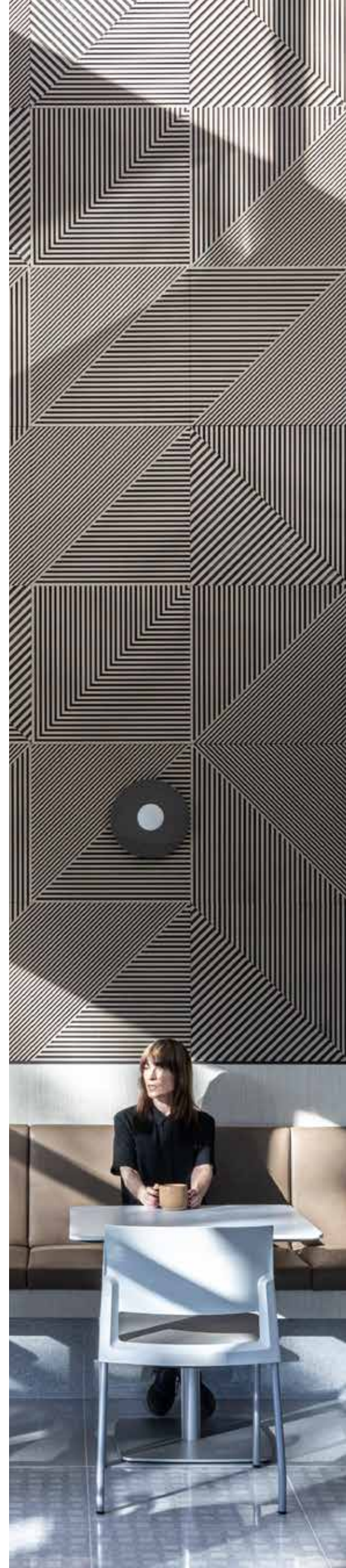

✓ RETURN TO TABLE OF CONTENTS

MORE ARCHITECTURE

Architect **Michael Banman** is the Canada West Design Director for Stantec's Buildings practice and leads the design teams across academic, institutional, healthcare, commercial, retail, hospitality, and cultural projects from Stantec's studio in downtown Winnipeg, MB.

David Martin is the Global Design Director for the Buildings practice and has led the design of numerous award-winning healthcare, research, and education projects in the United Kingdom, United States, Canada, and the Middle East.

MB: It's still all about achieving design excellence. If it's not a great space, I'm not that interested. I have to be brutally honest about it. You can tell me a hundred great stories about a project, but what I'm really interested in is the quality of space, proportion, scale, materials, details, continuity, light, shadow, rhythm, sequence, and experience; it still has to be a well-designed space. It's about both and not either or.

It has to be excellent design using technologies and techniques to address a wide range of issues related to budget, function, and performance, with clarity and vision to ultimately shape experience.

DM: It is both. A lot of which comes down to what elements we bring to it. For example, I'm curious about neuroscience and cognitive architecture—about incorporating that in benchmarking or in tools for design simulation. We know, for example, that 90% of people will aggregate close to one wall, within 5% of the total space—maybe we can trace that back to the hunter gatherers. How can we absorb that research into what we do? Or do we?

Architecture is not a linear formula. It can't be solved by algebra and to your point, Michael, if it's not a good space, who cares. But often that good space exists because a designer was involved in its creation and they take those formulas, the ideas, those tools and apply them, but in a deeply personal way.

Without that alchemy of the scientific process combined with intuition, a little bit of chance and aesthetic preferences, it's not architecture, it's not design. **DA**



Is this role different from what people think architects do in some ways? Gathering ideas and information? Finding that overlap? Or is this an additional role?

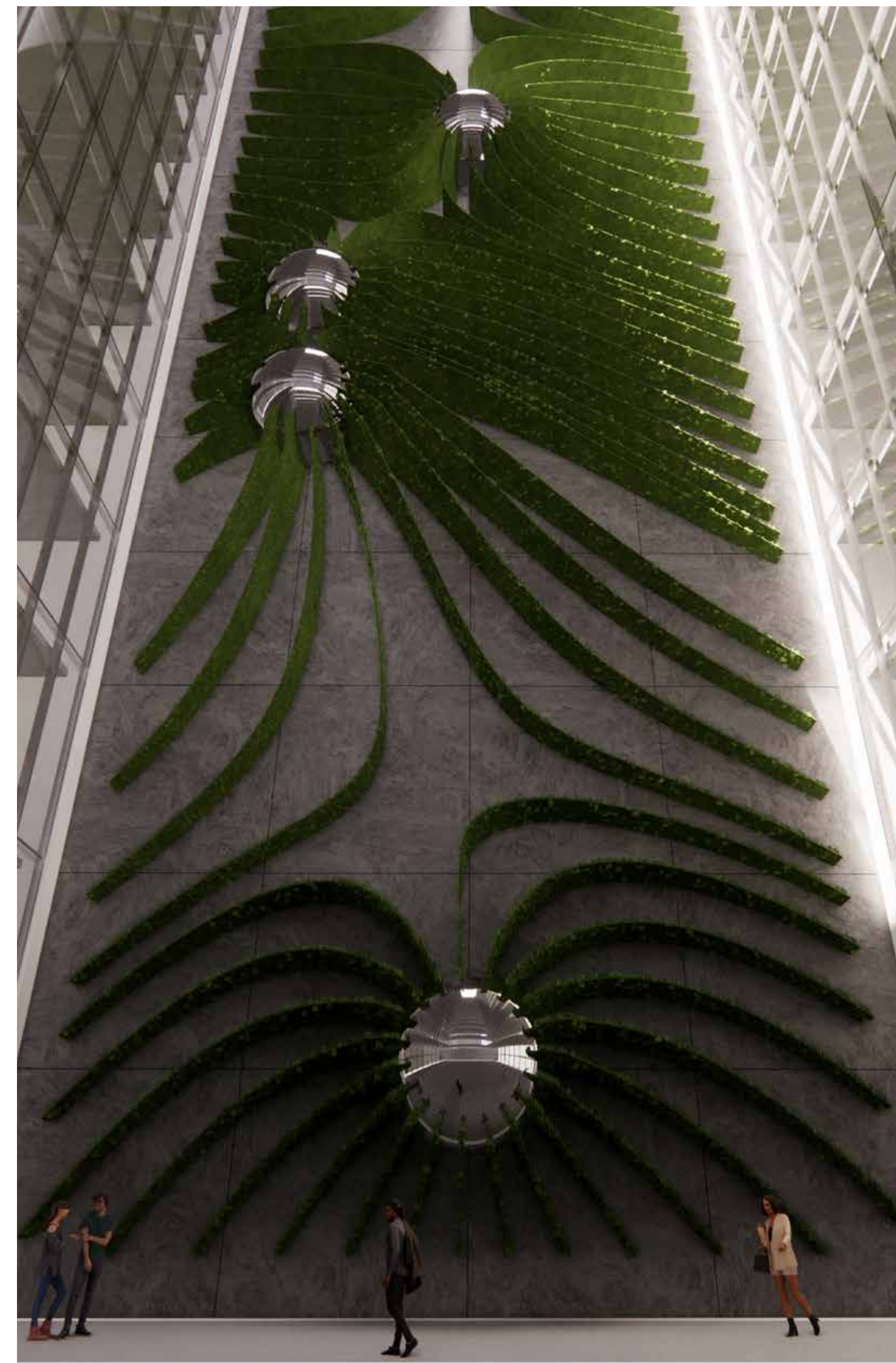



DESIGN QUAR- TERLY

SUBSCRIBE STANTEC DESIGN QUARTERLY

Executive Editors **Andrea Johnson** and **Summer Heck**
Editor **John Dugan**
Graphic Design **Miranda Esteve**

© 2023 by Stantec. All rights reserved. Images except where noted © Stantec.